

Gráfico 14A

INDICADORES DE FRAGILIDAD SOCIAL: POR LOCALIDAD



Gráfico 14B

INDICADORES DE FRAGILIDAD SOCIAL POR LOCALIDAD

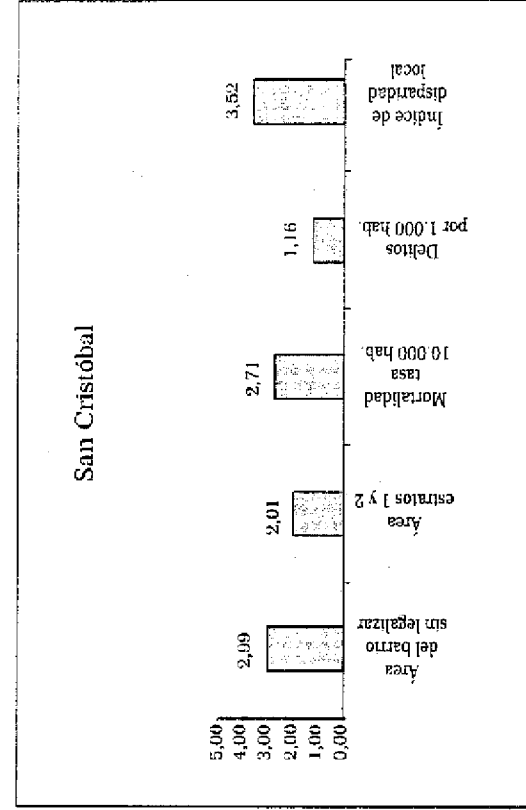
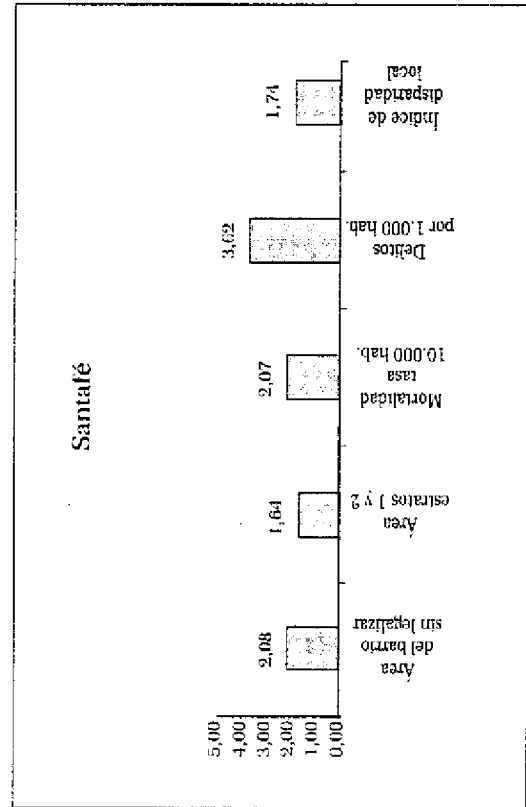
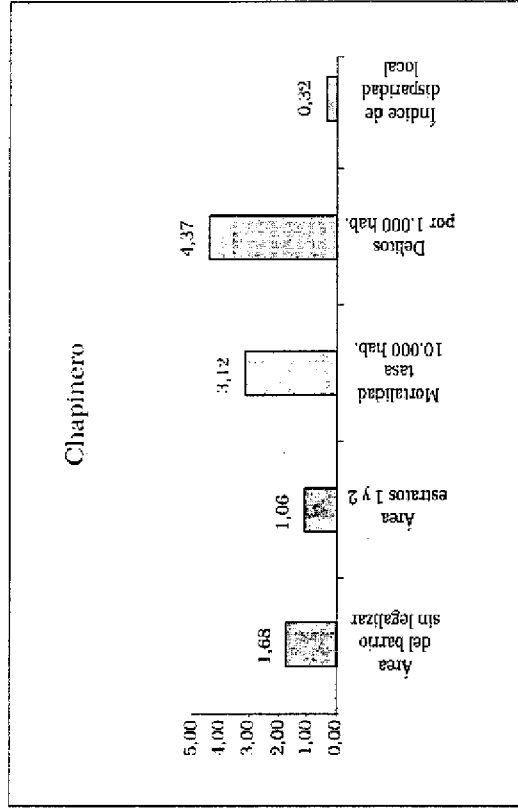
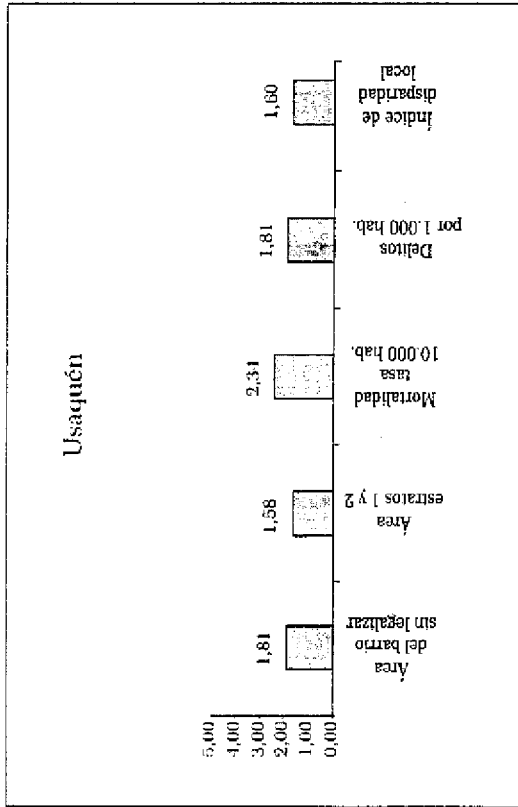

Gráfico 14C

INDICADORES DE FRAGILIDAD SOCIAL POR LOCALIDAD

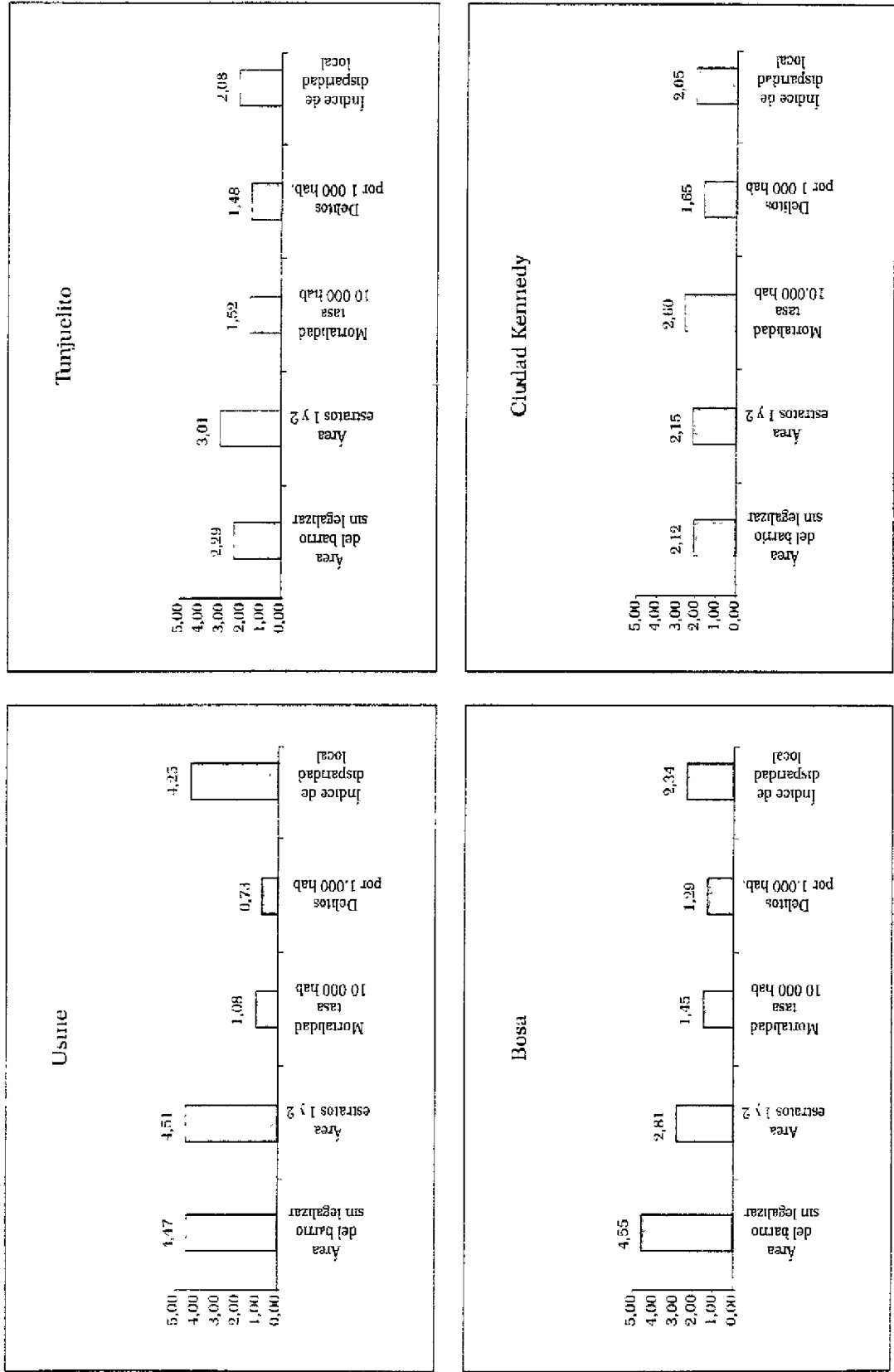

Gráfico 14D

INDICADORES DE FRAGILIDAD SOCIAL POR LOCALIDAD

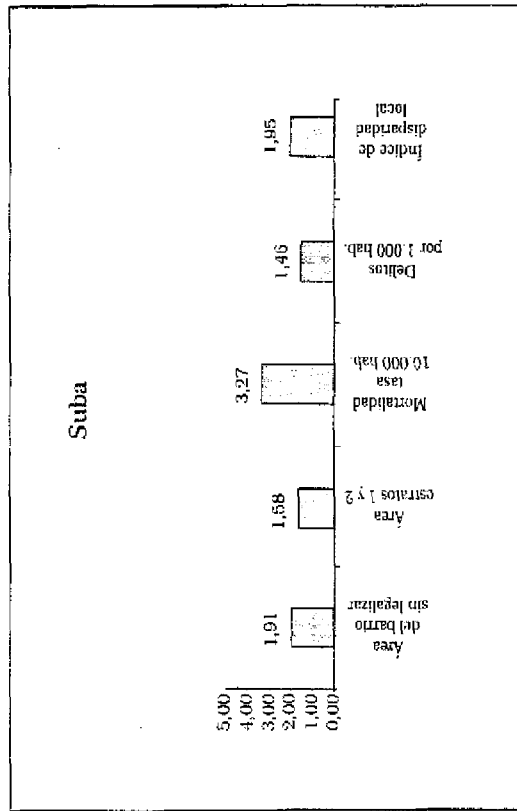
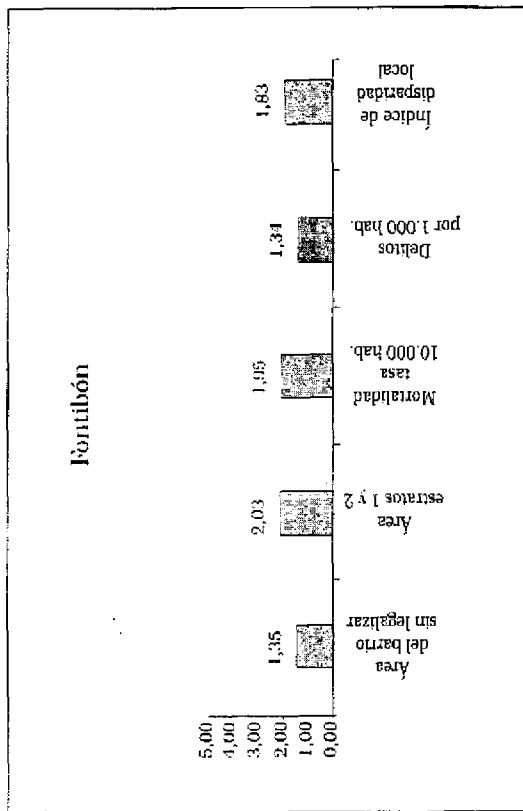
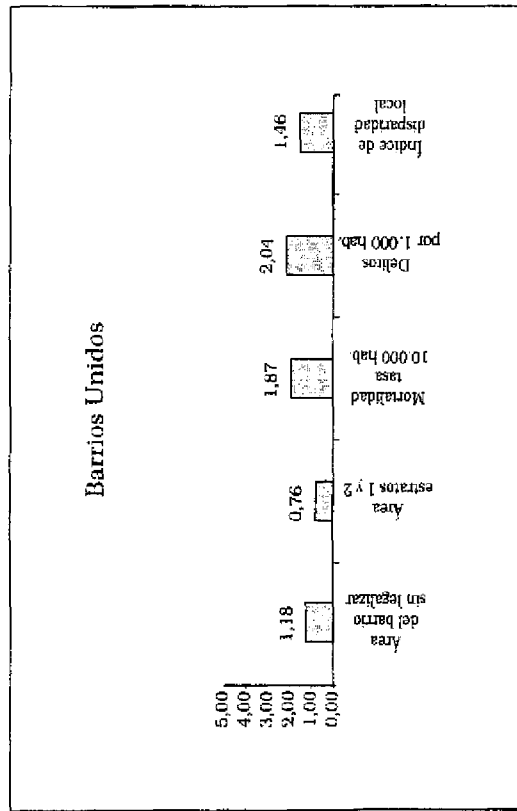
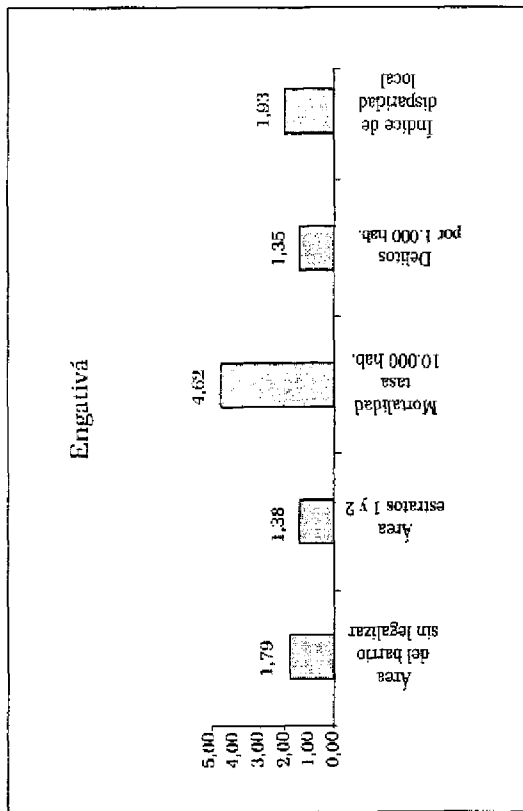

Gráfico 14E

INDICADORES DE FRAGILIDAD SOCIAL POR LOCALIDAD

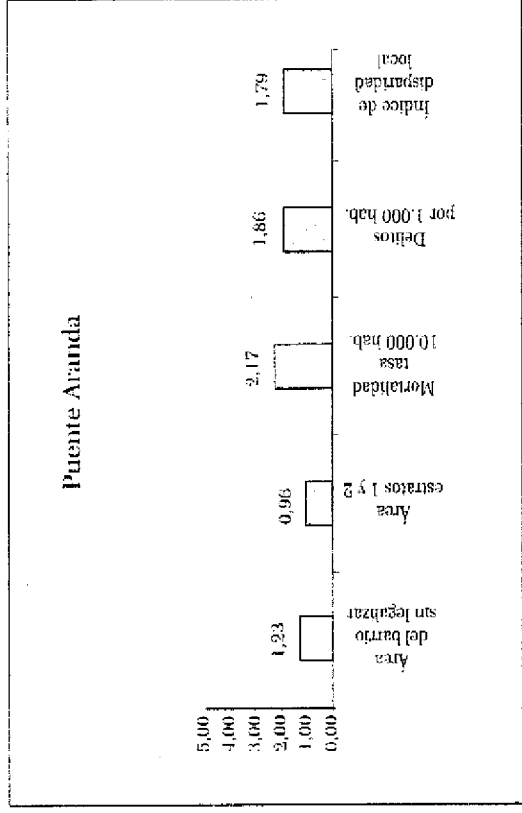
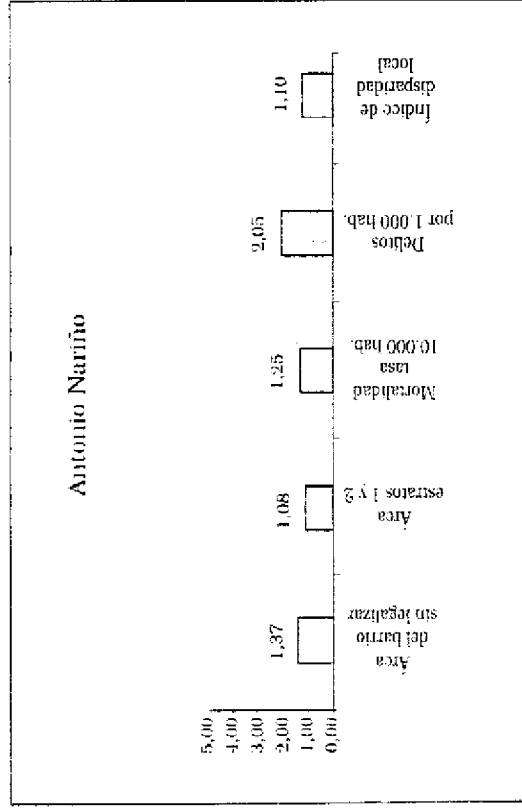
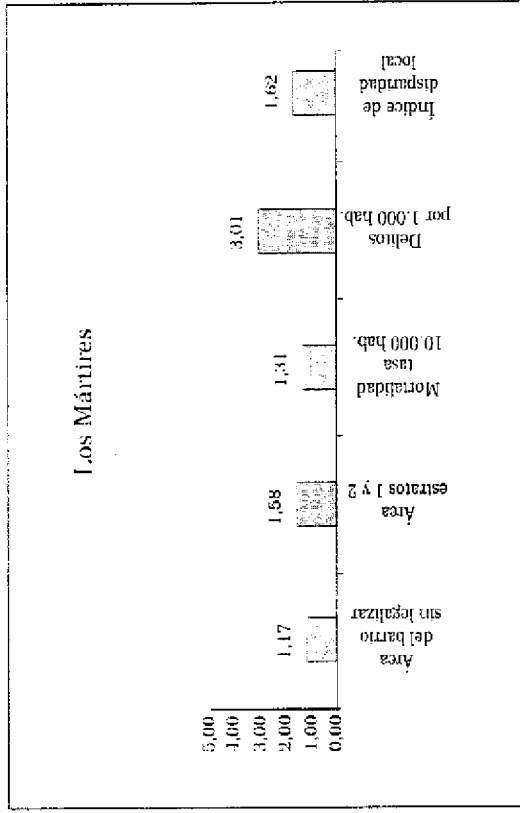
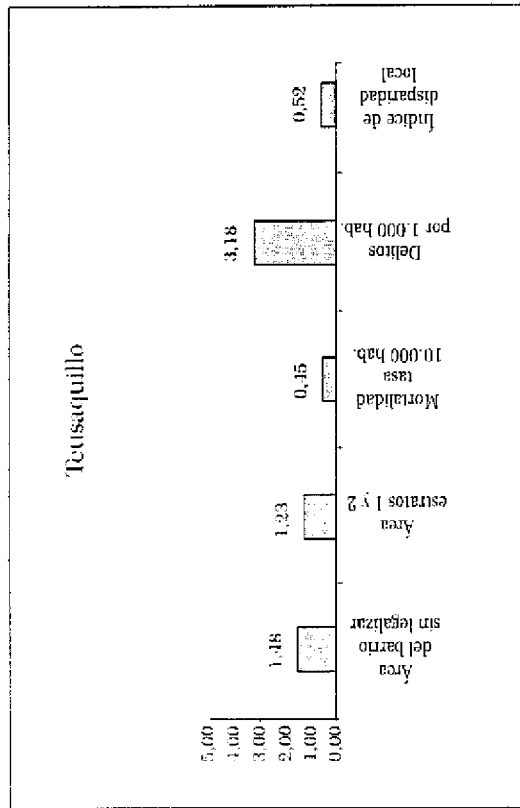

Gráfico 15A

INDICADORES DE ÁREA DE BARRIOS SIN LEGALIZAR Y DE ESTRATOS 1 Y 2 POR LOCALIDAD



Gráfico 15B
INDICADORES DE MORTALIDAD Y DELITOS POR LOCALIDAD

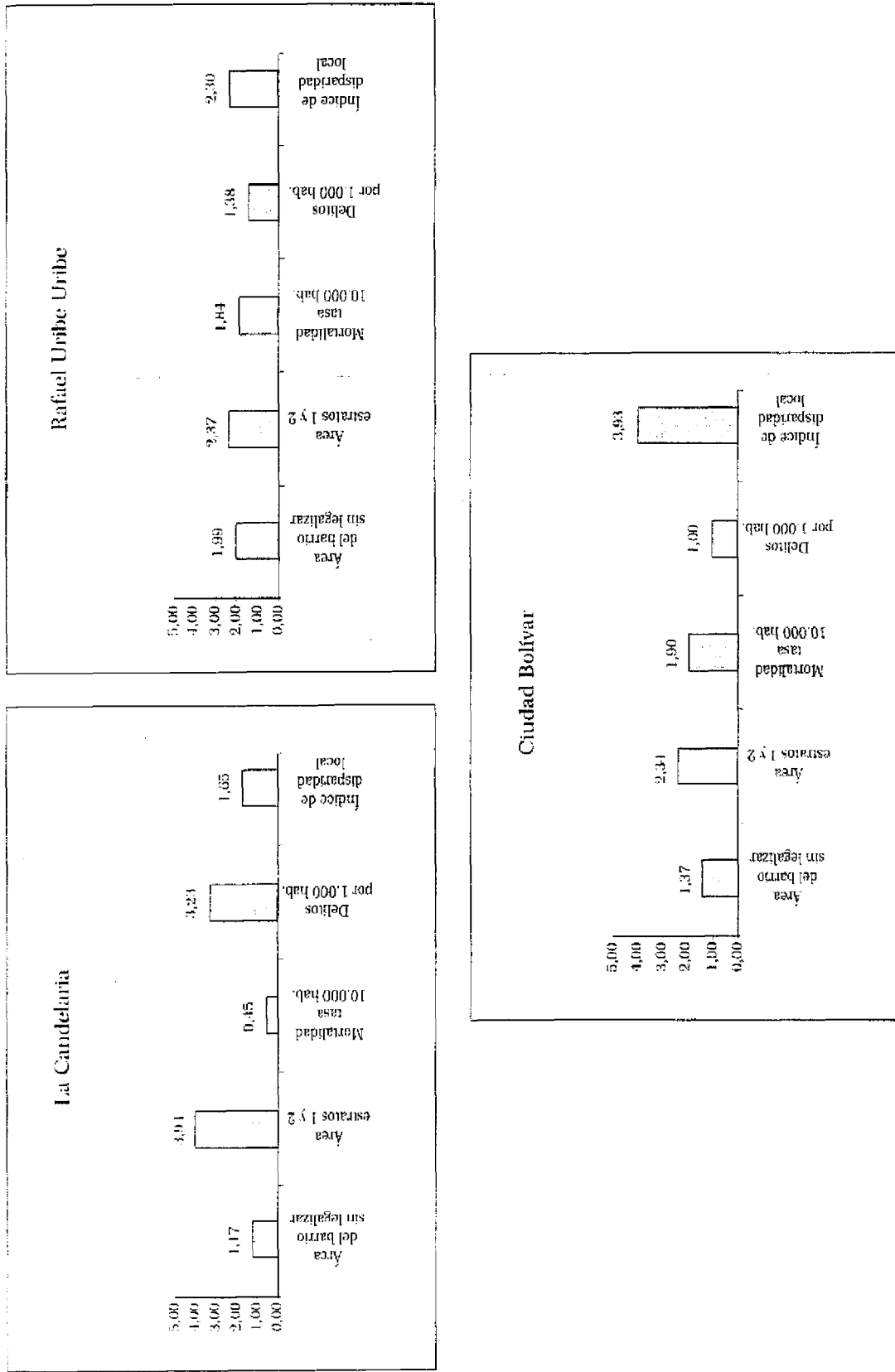

Gráfico 15C

INDICADORES DE ÍNDICE DE DISPARIDAD LOCAL POR LOCALIDAD

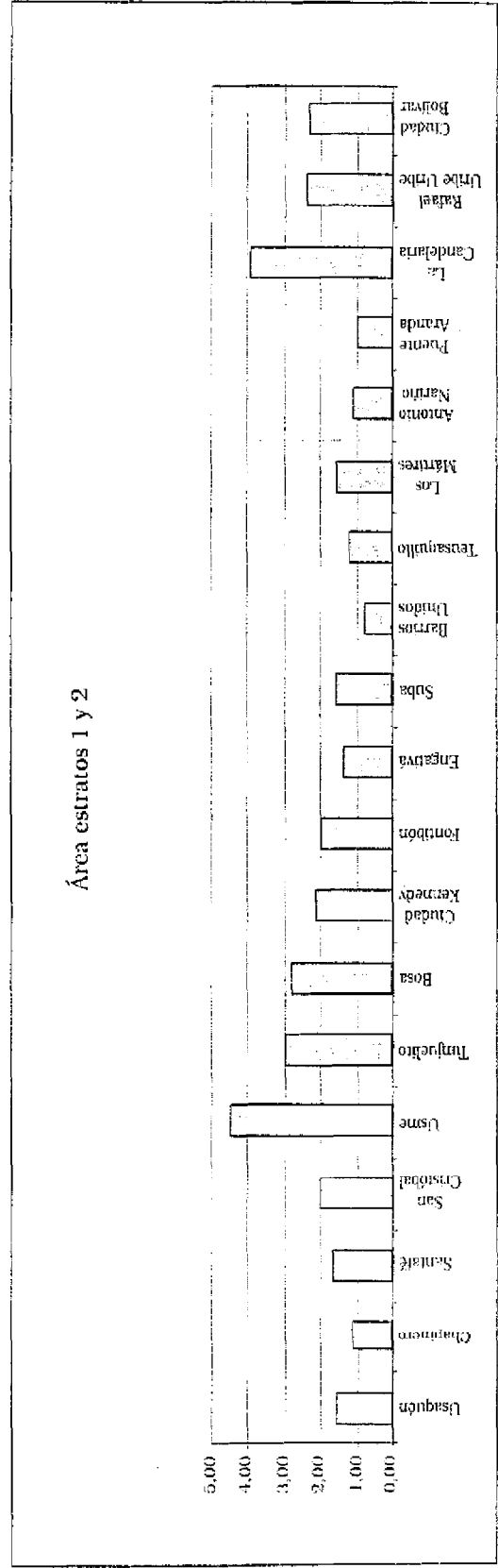
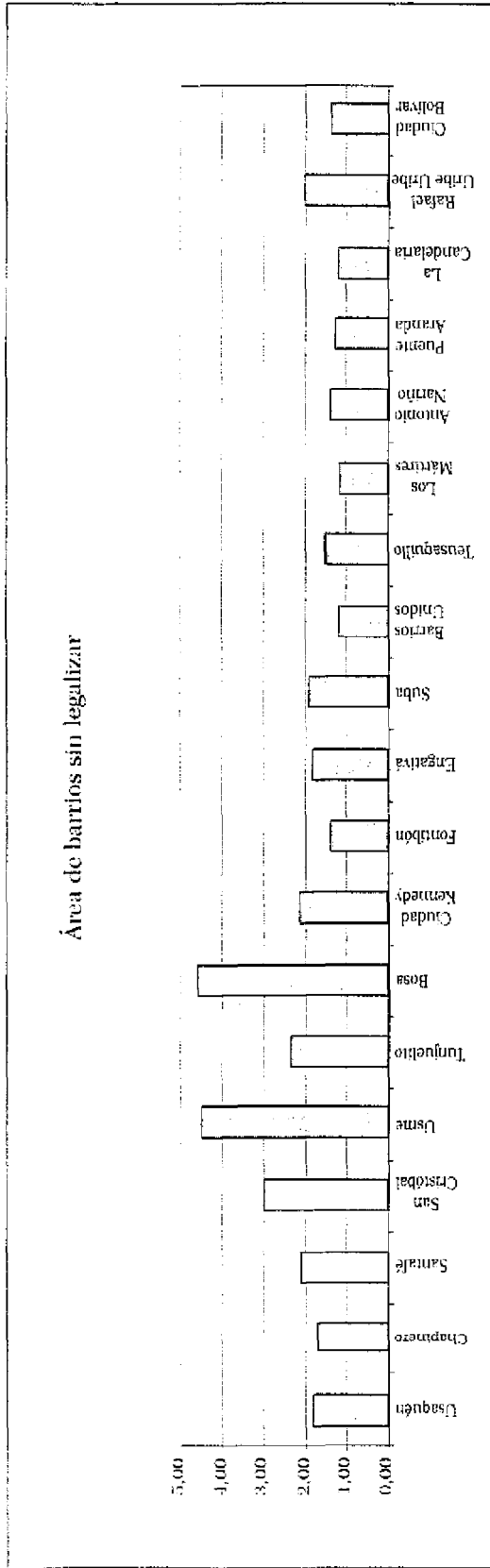

Gráfico 16

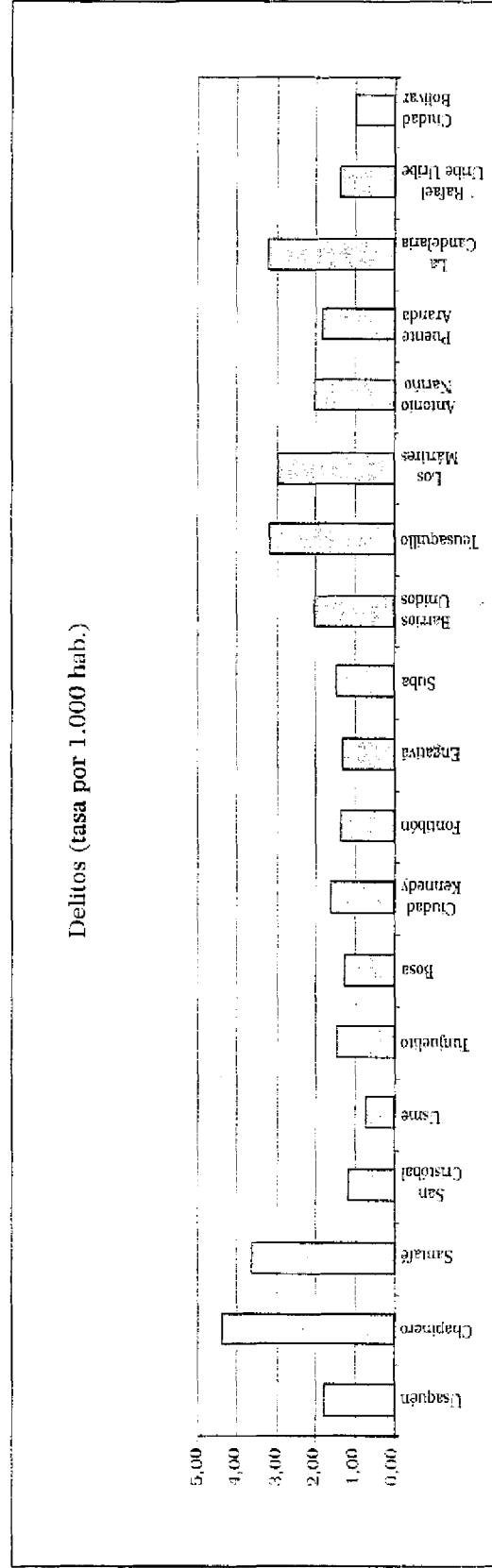
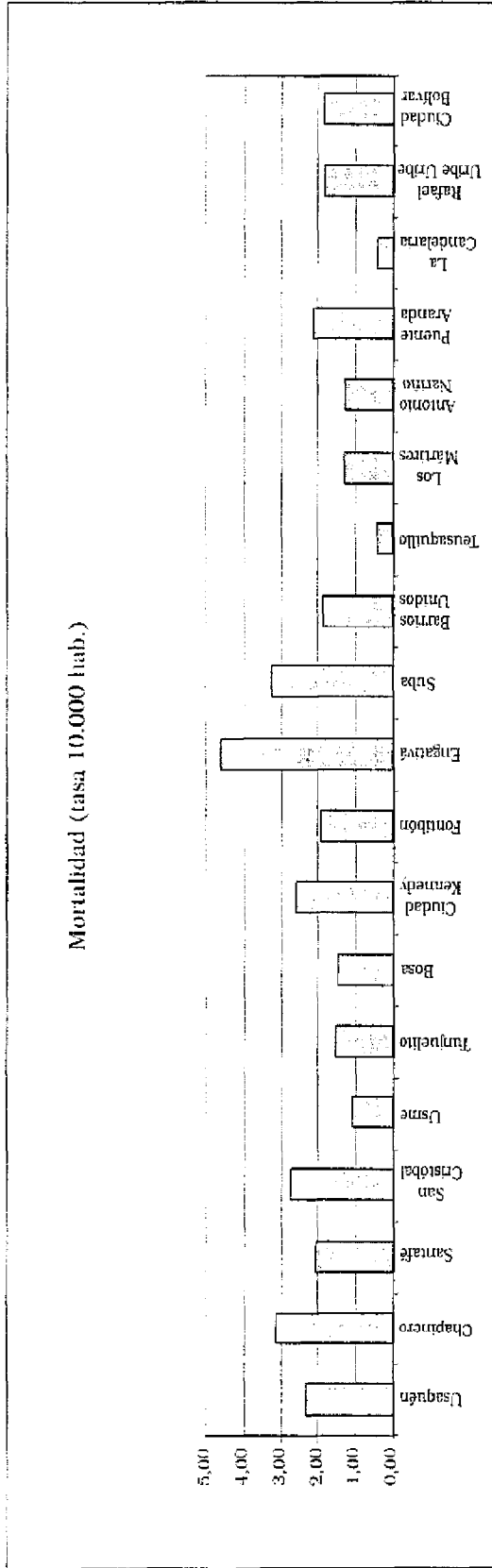
INDICADORES DE ÍNDICE DE FRAGILIDAD SOCIAL POR LOCALIDAD



Gráfico 17A
INDICADORES DE RESILIENCIA POR LOCALIDAD

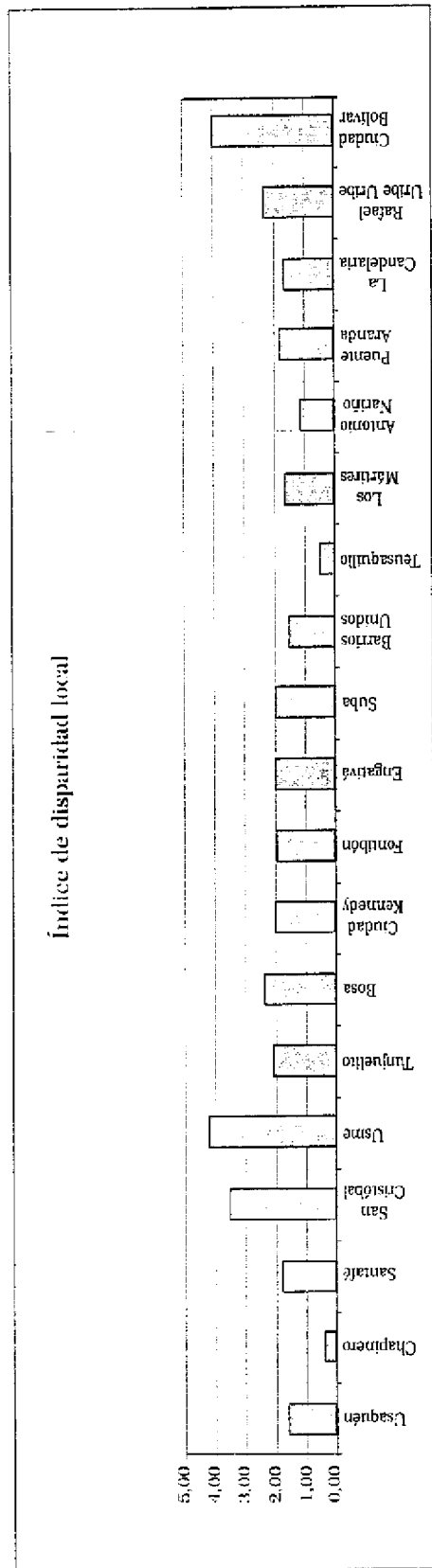

Gráfico 17B
INDICADORES DE RESILIENCIA POR LOCALIDAD

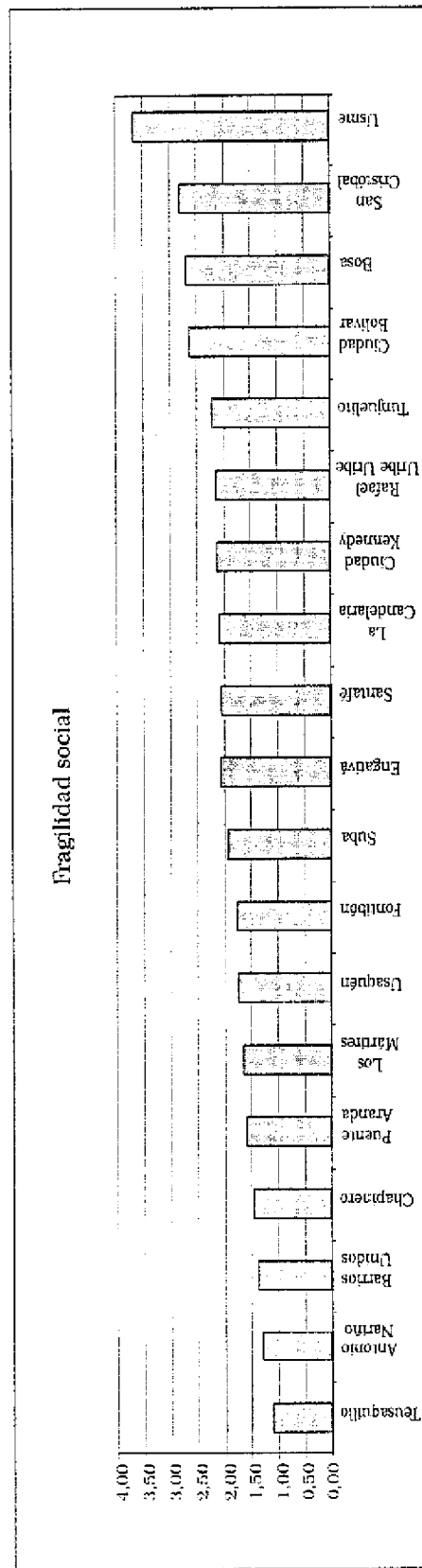

Gráfico 17C
INDICADORES DE RESILIENCIA POR LOCALIDAD

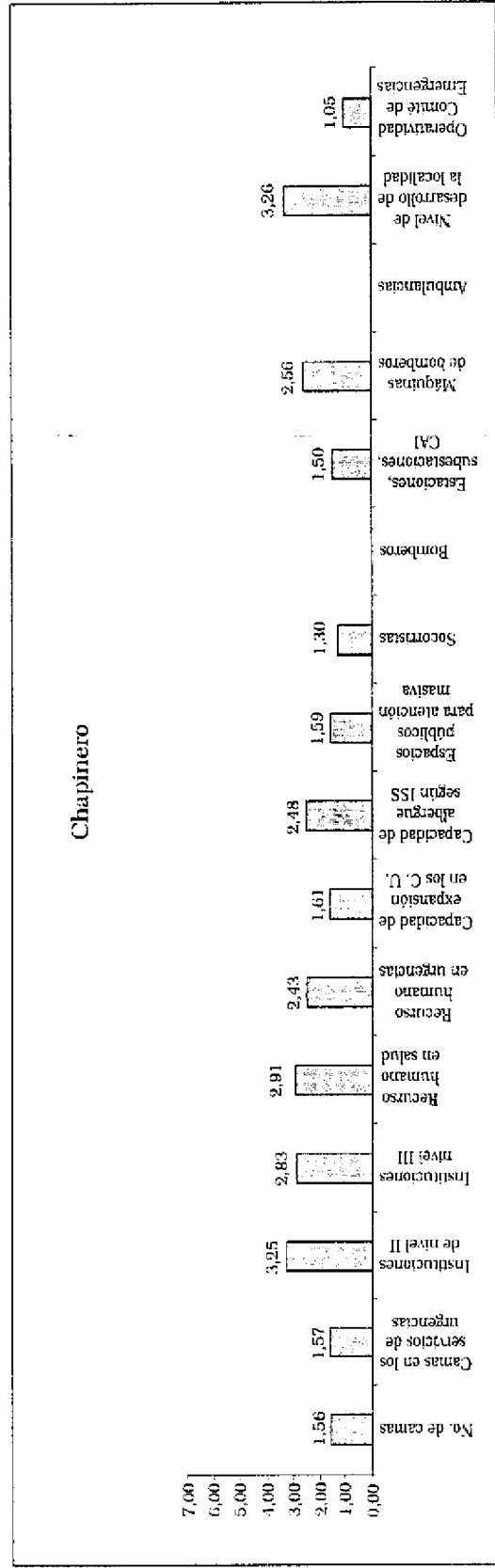
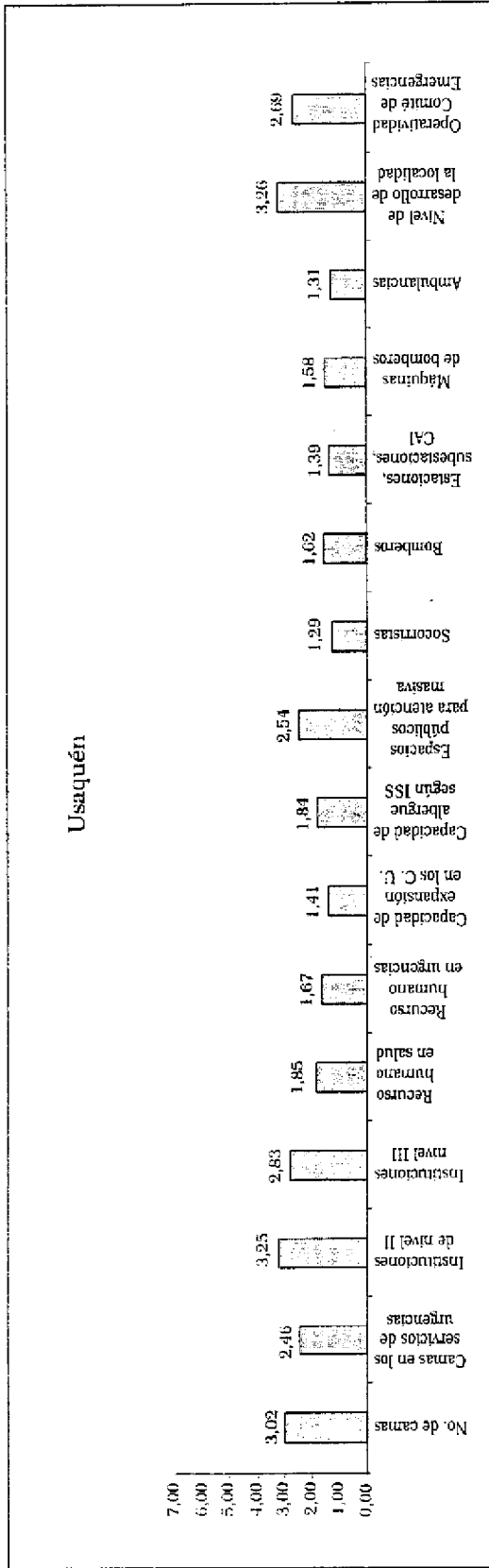

Gráfico 17D

INDICADORES DE RESILIENCIA POR LOCALIDAD

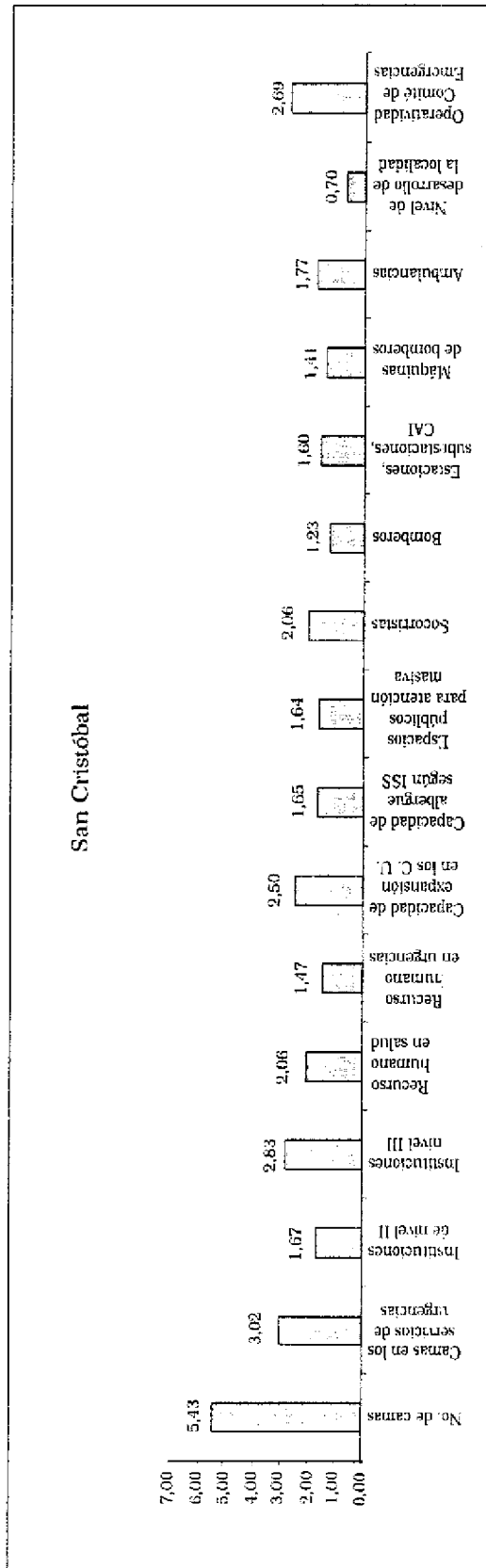
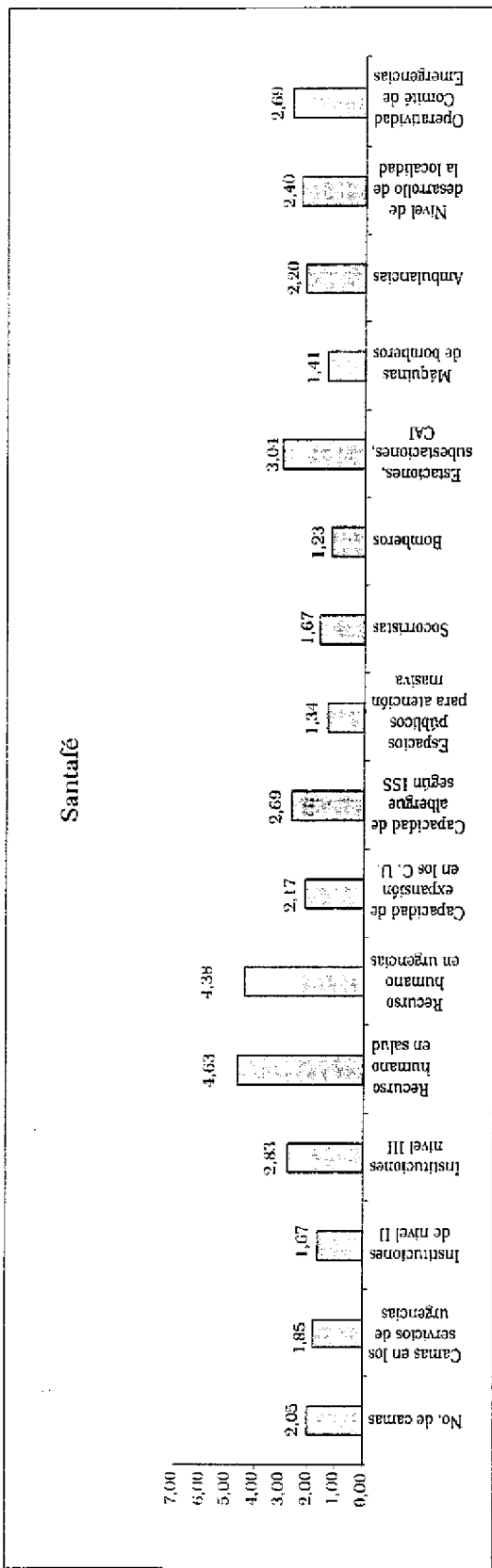

Gráfico 17E

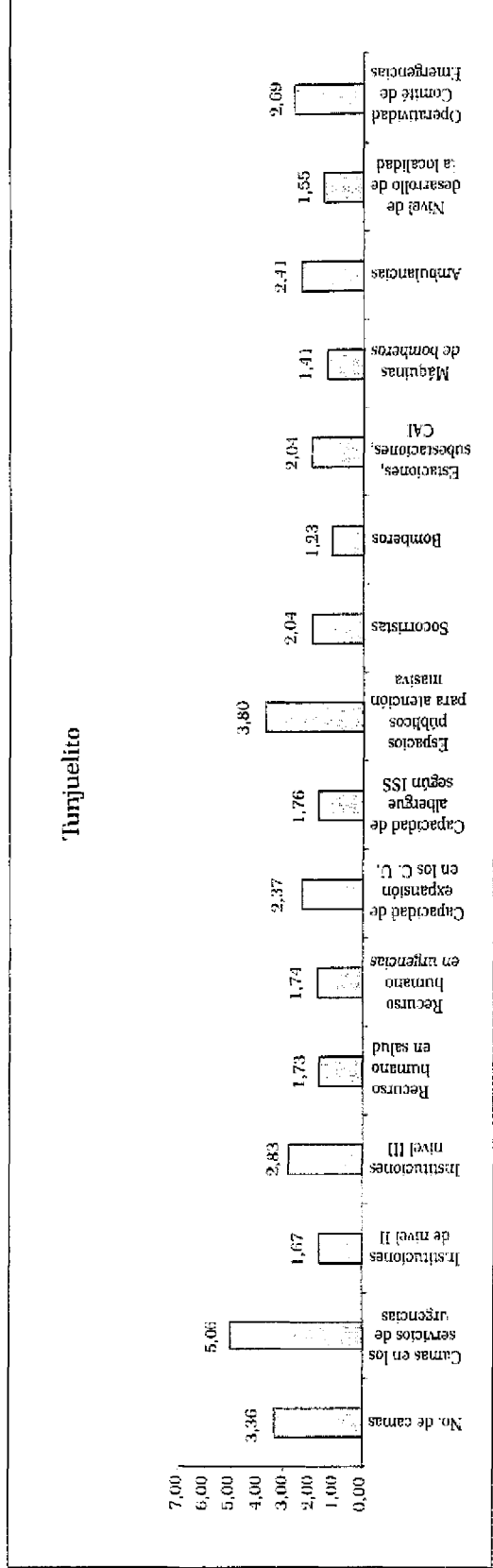
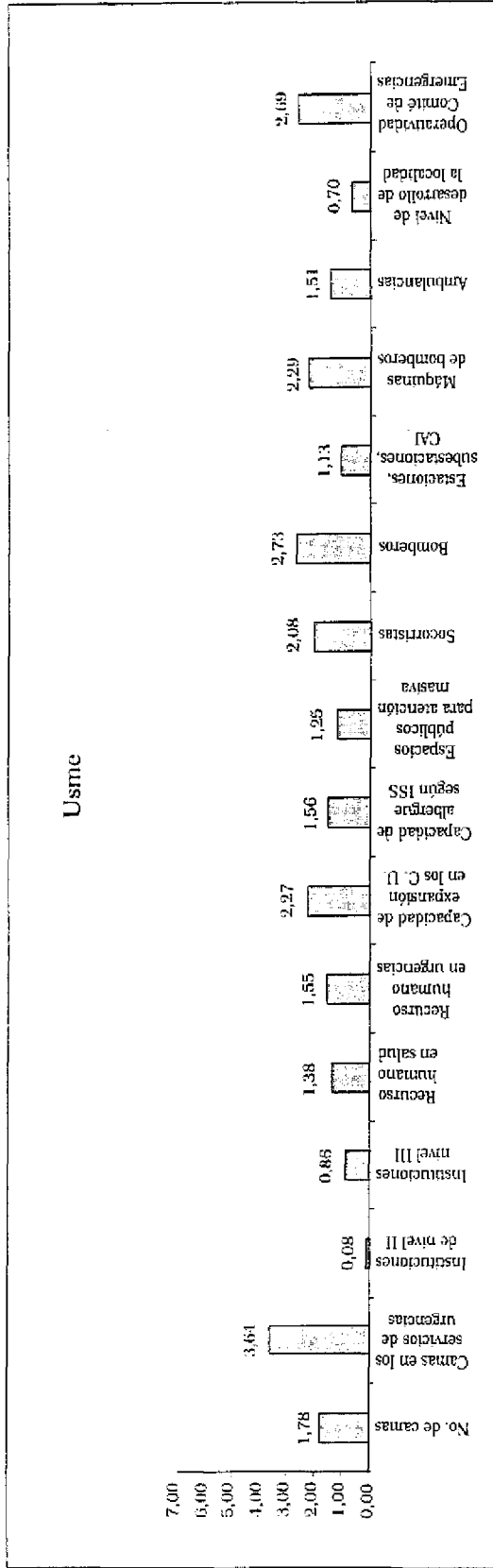
INDICADORES DE RESILIENCIA POR LOCALIDAD

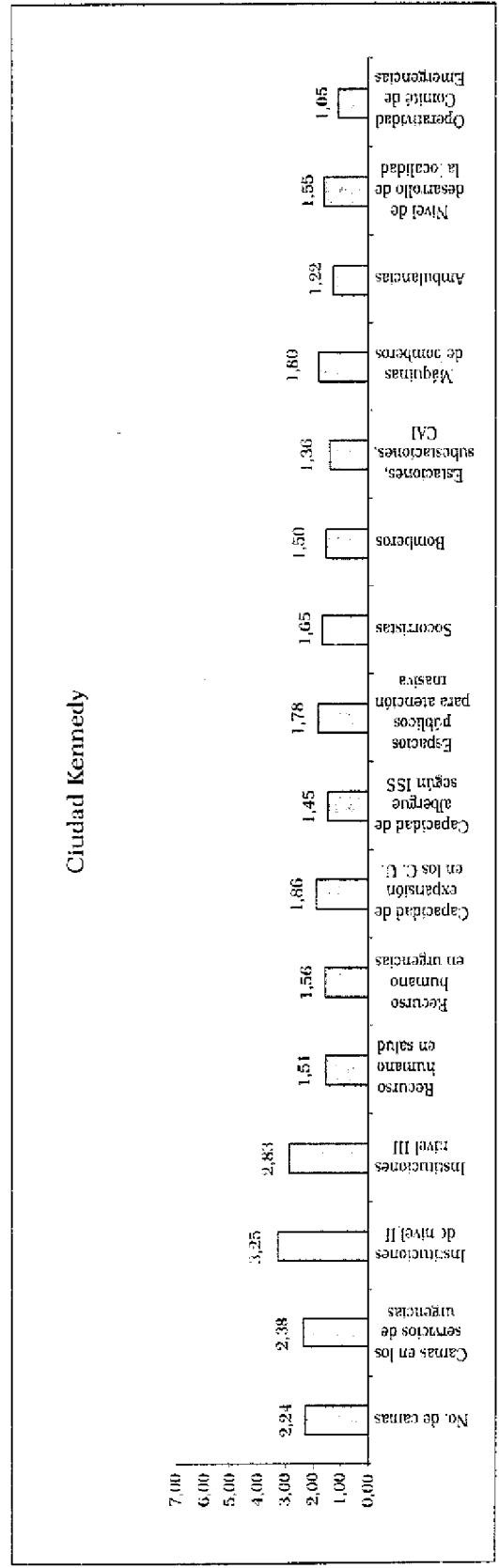
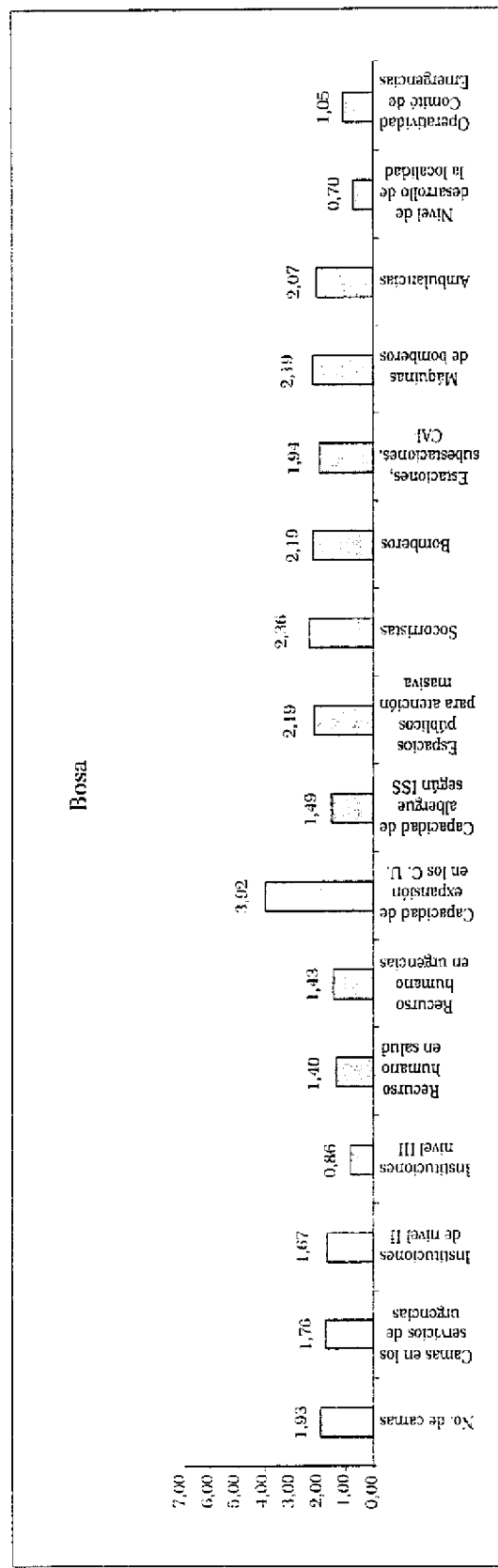

Gráfico 17F

INDICADORES DE RESILIENCIA POR LOCALIDAD



Gráfico 176
INDICADORES DE RESILIENCIA POR LOCALIDAD

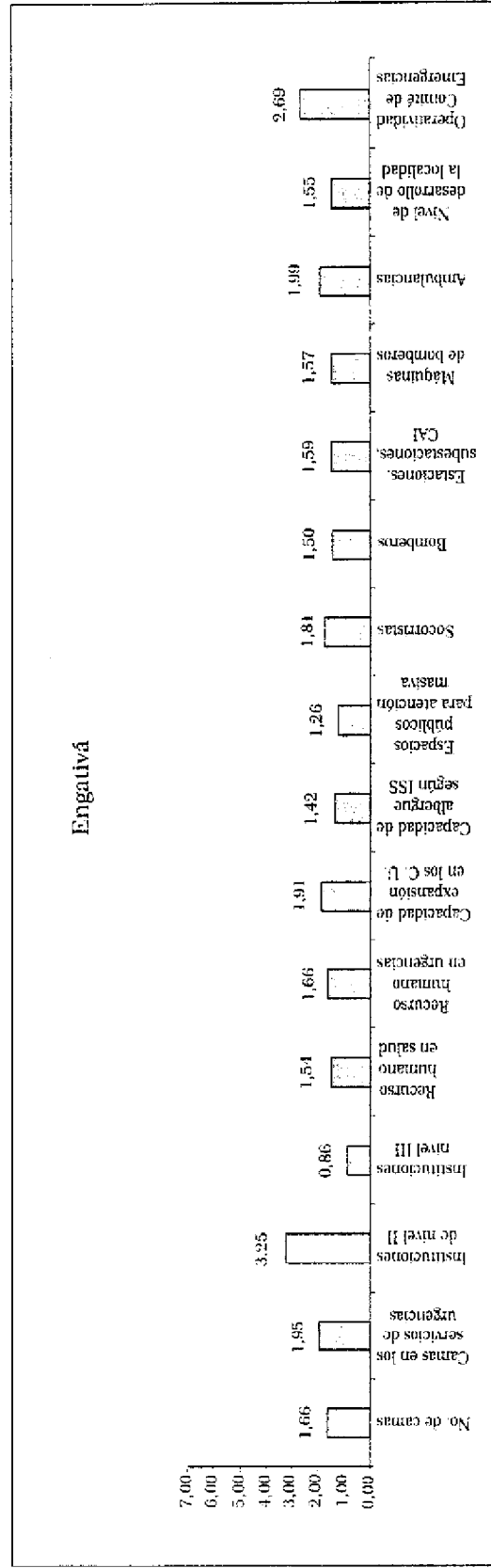
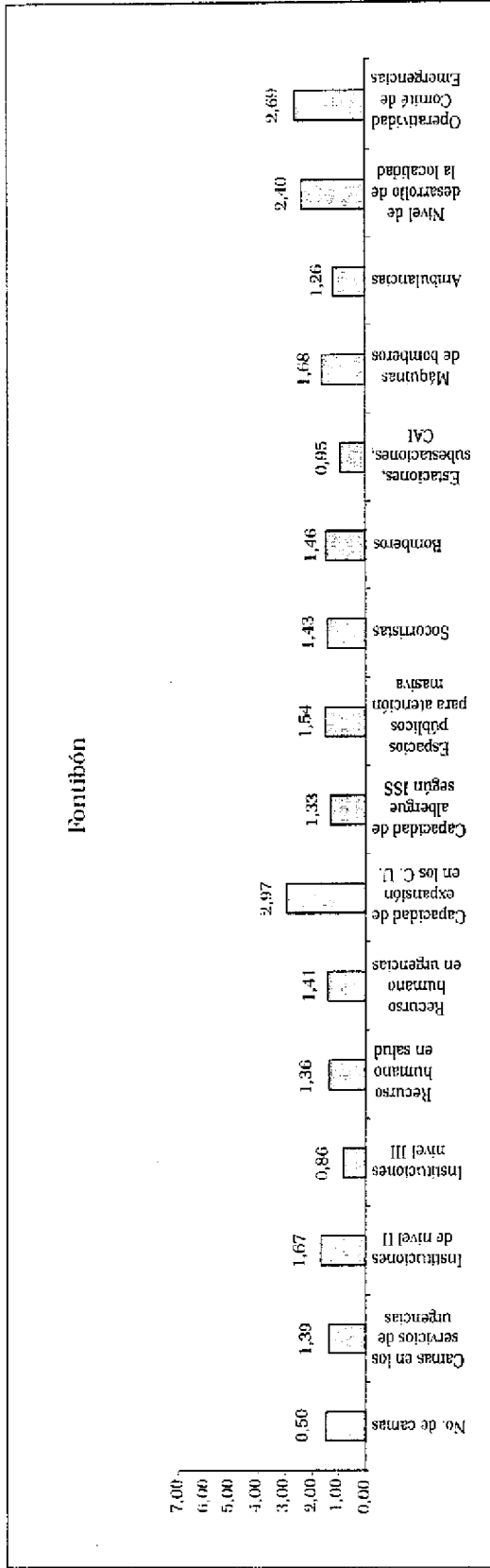

Gráfico 17H

INDICADORES DE RESILIENCIA POR LOCALIDAD

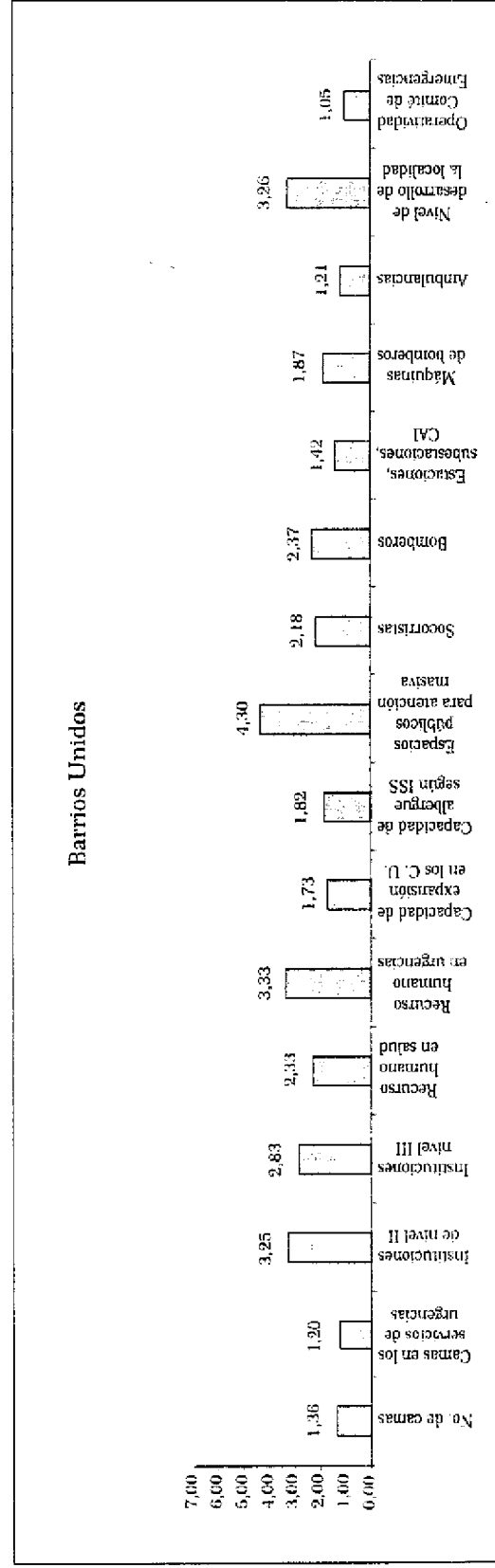
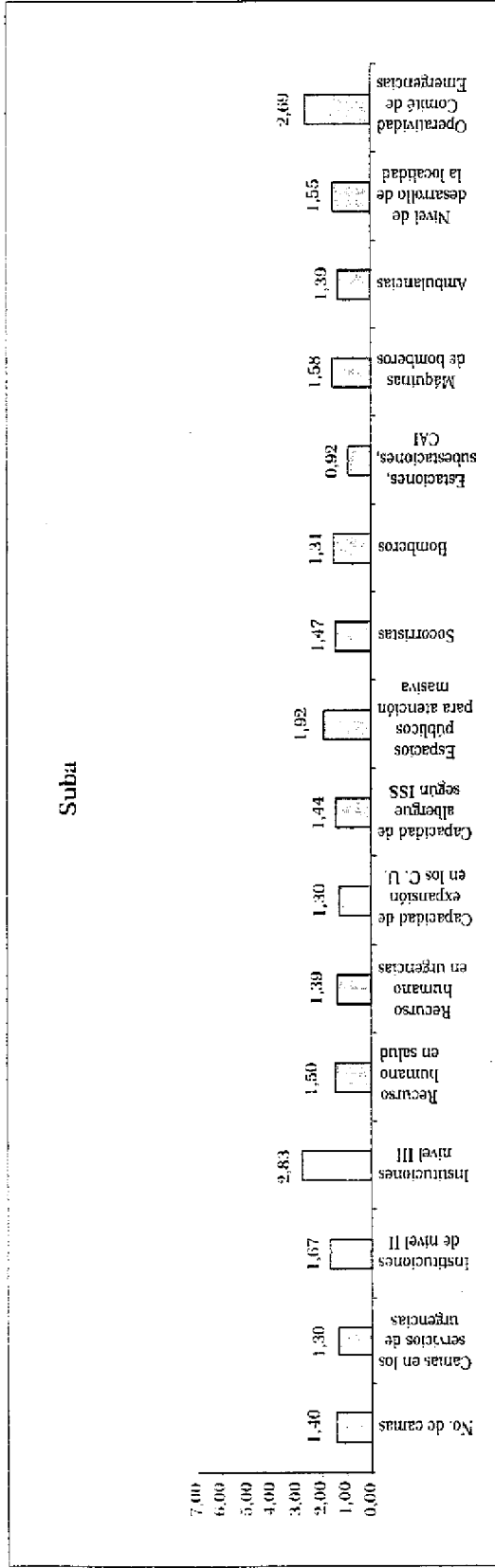

Gráfico 171
INDICADORES DE RESILIENCIA POR LOCALIDAD

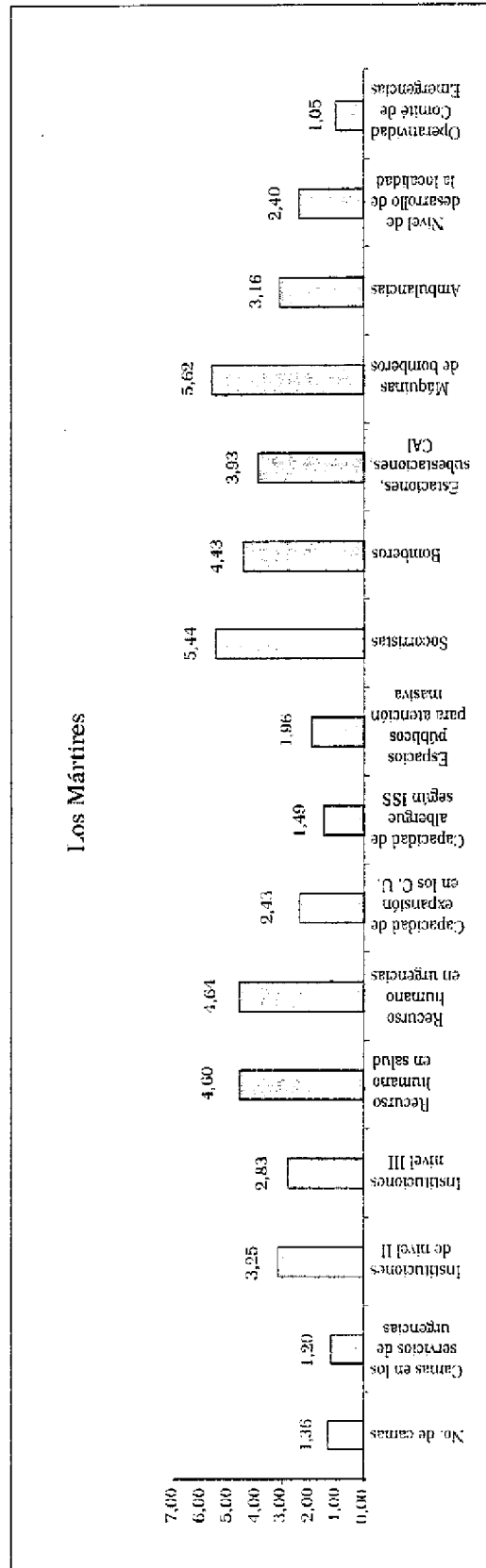
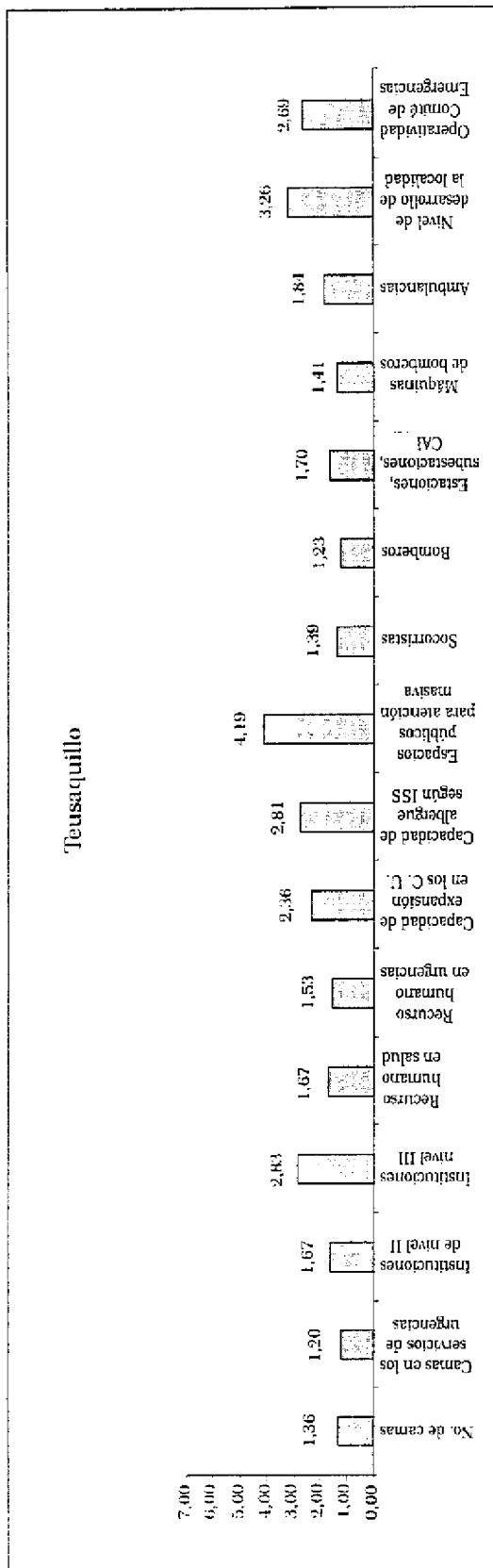

Gráfico 17J
 INDICADORES DE RESILIENCIA POR LOCALIDAD

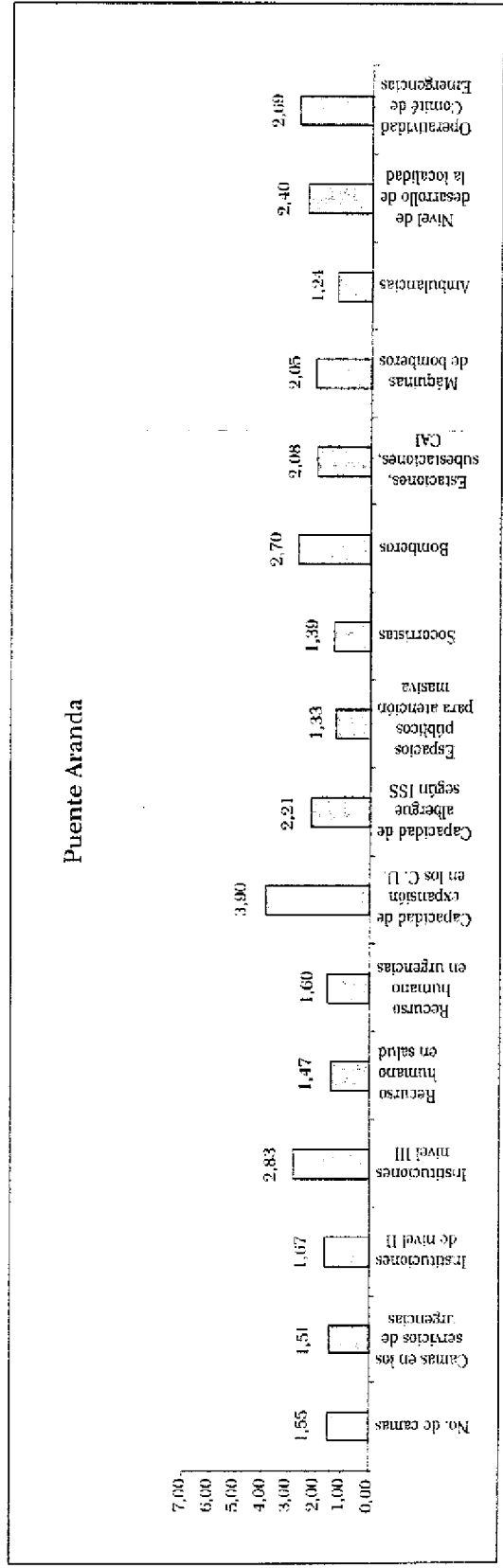
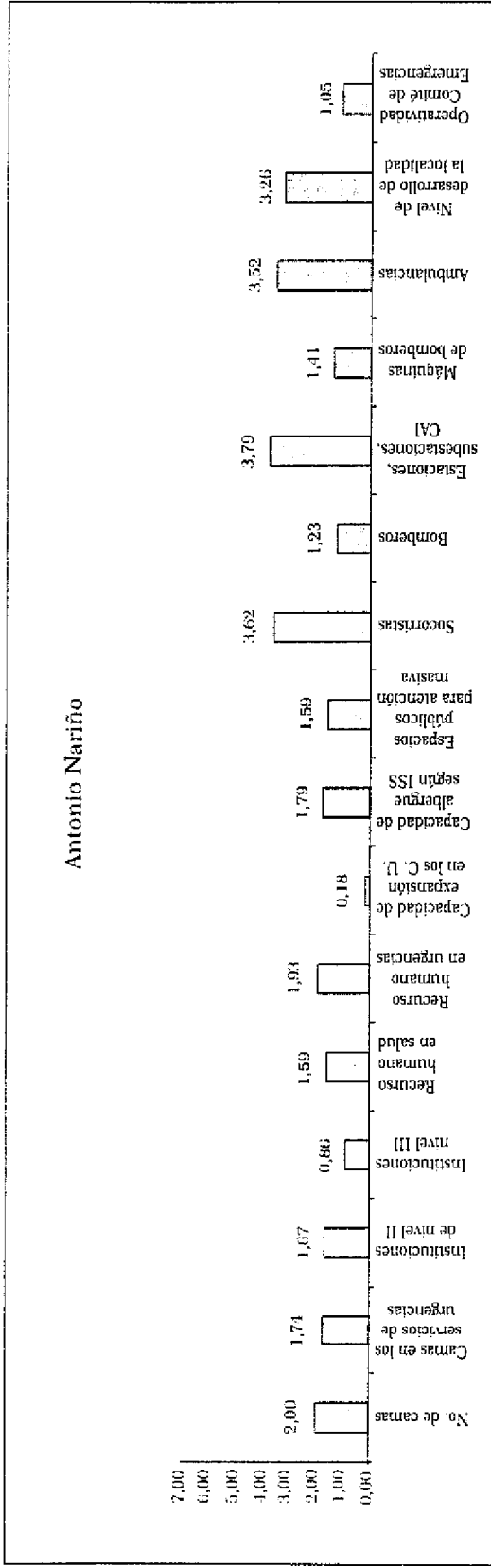

Gráfico 18A

INDICADORES DE NÚMERO DE CAMAS POR LOCALIDAD

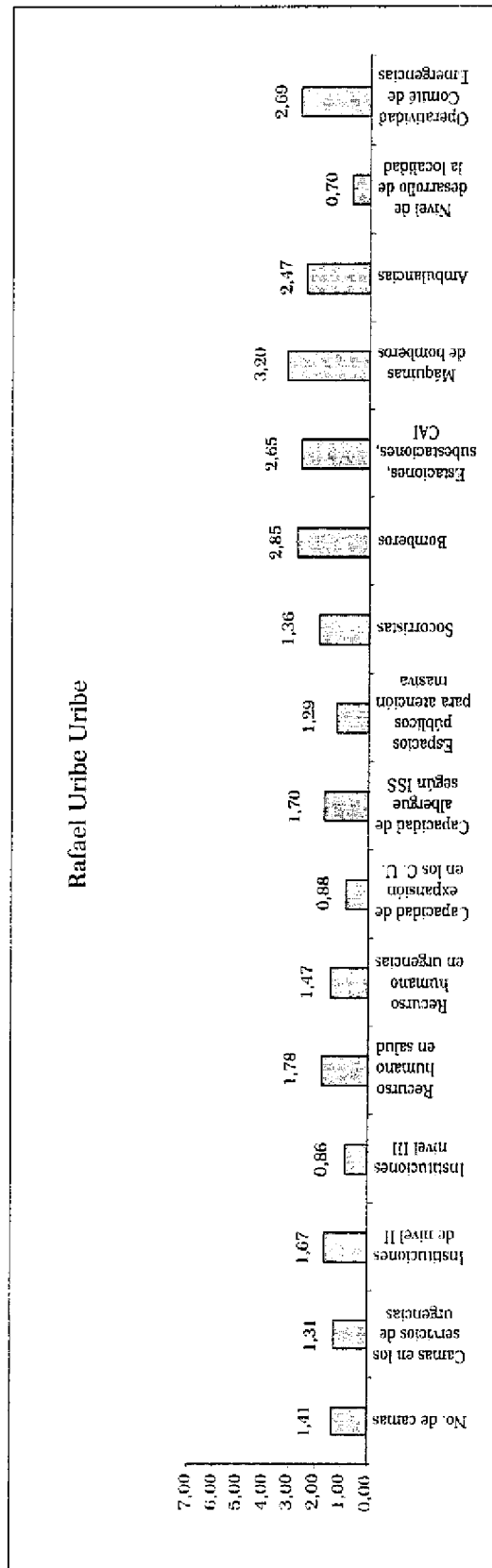
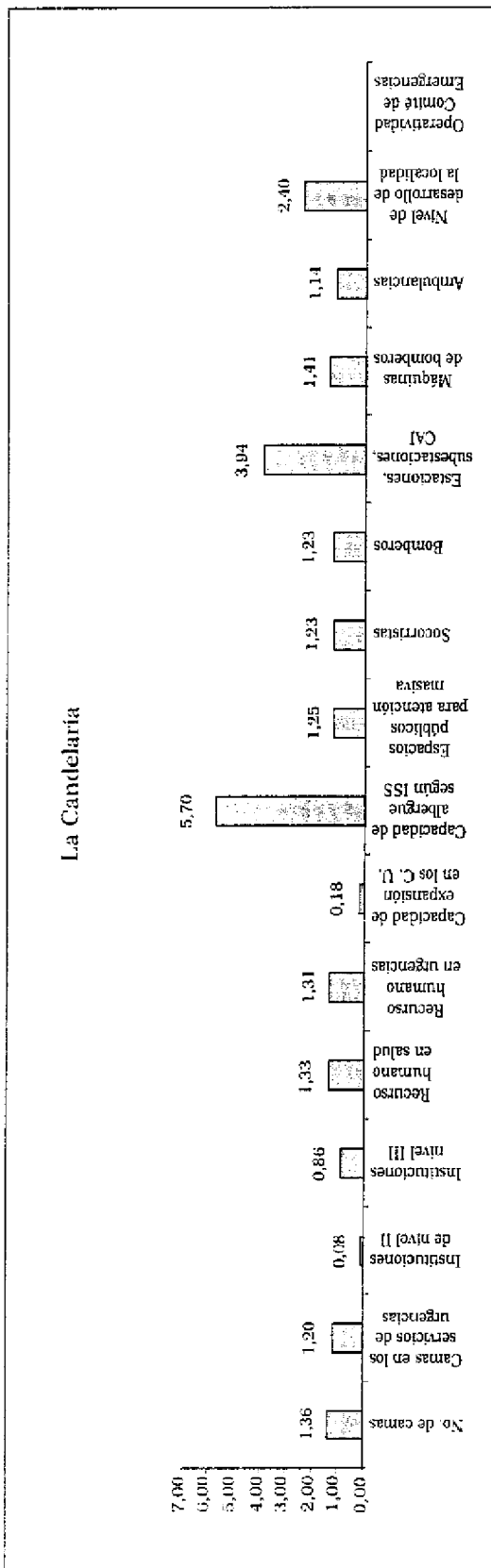

Gráfico 18B

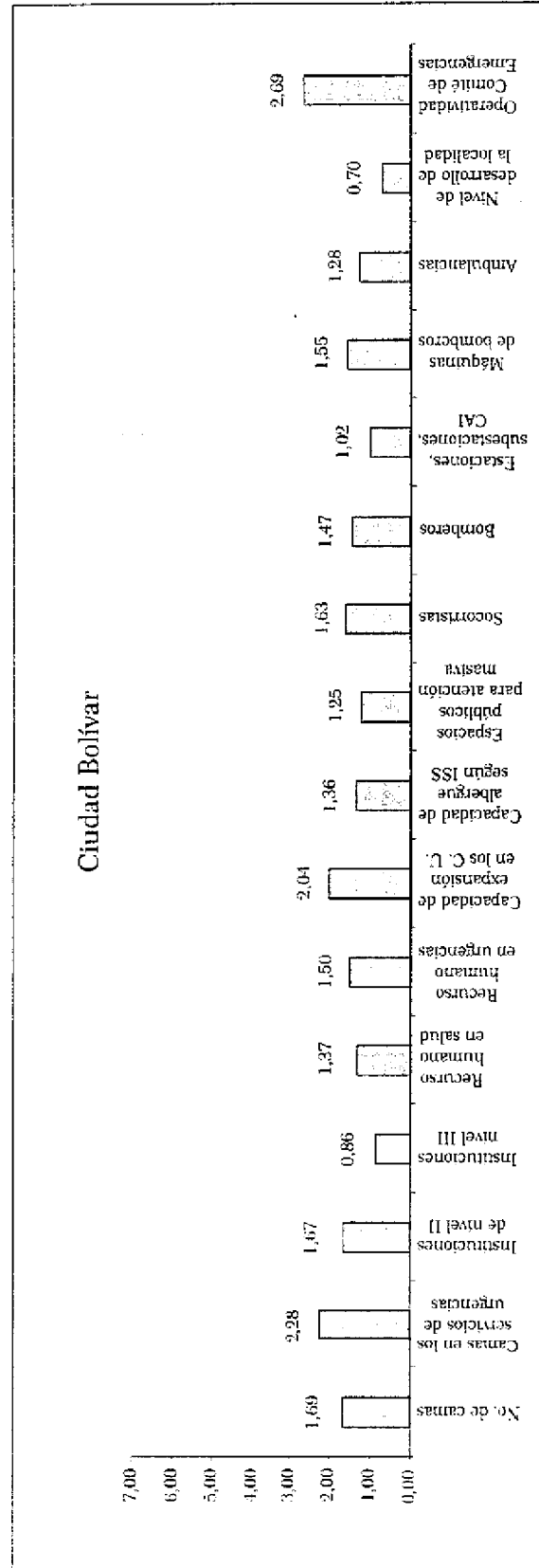
INDICADORES DE INSTITUCIONES DE NIVEL II Y III POR LOCALIDAD

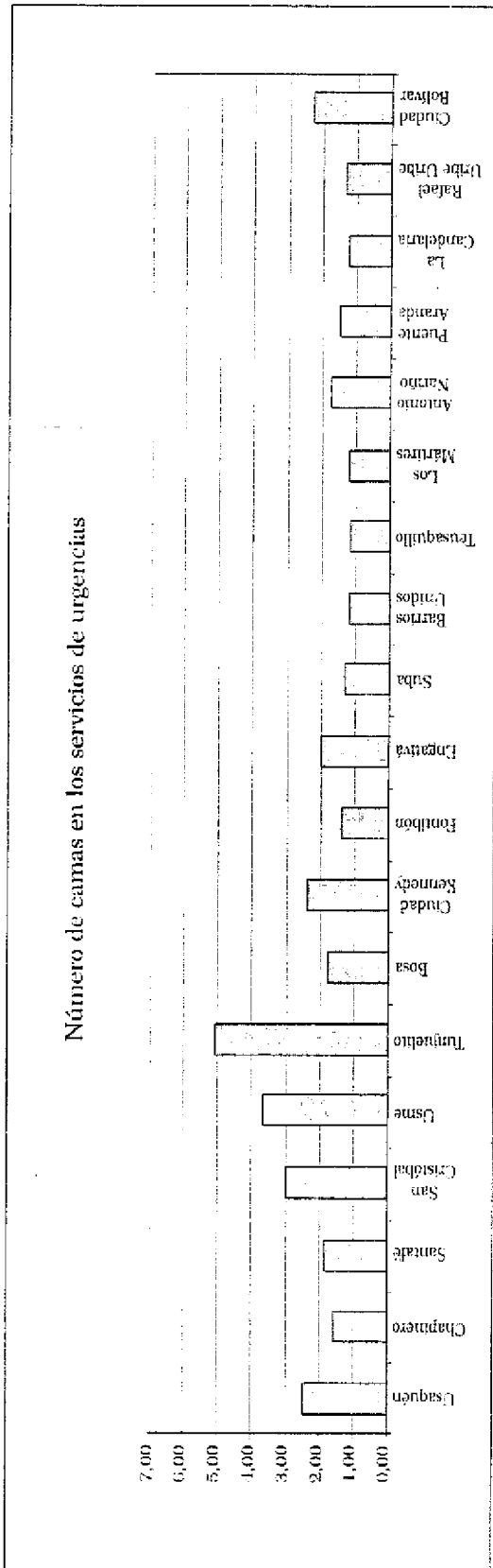
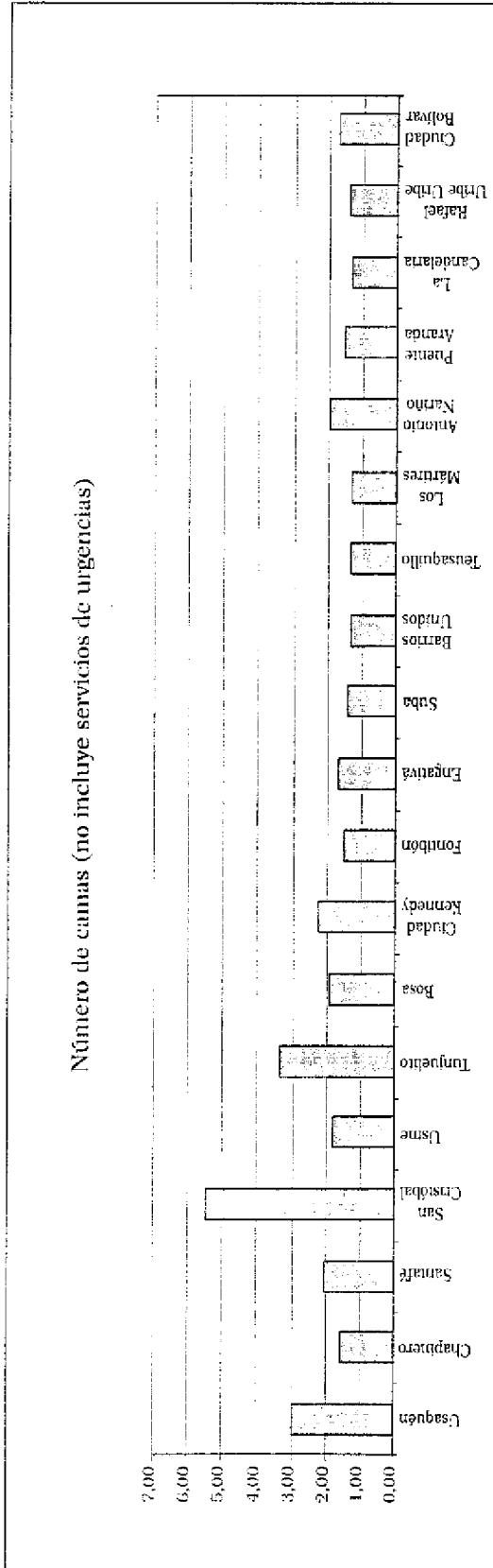

Gráfico 18C

INDICADORES DE RECURSO HUMANO POR LOCALIDAD

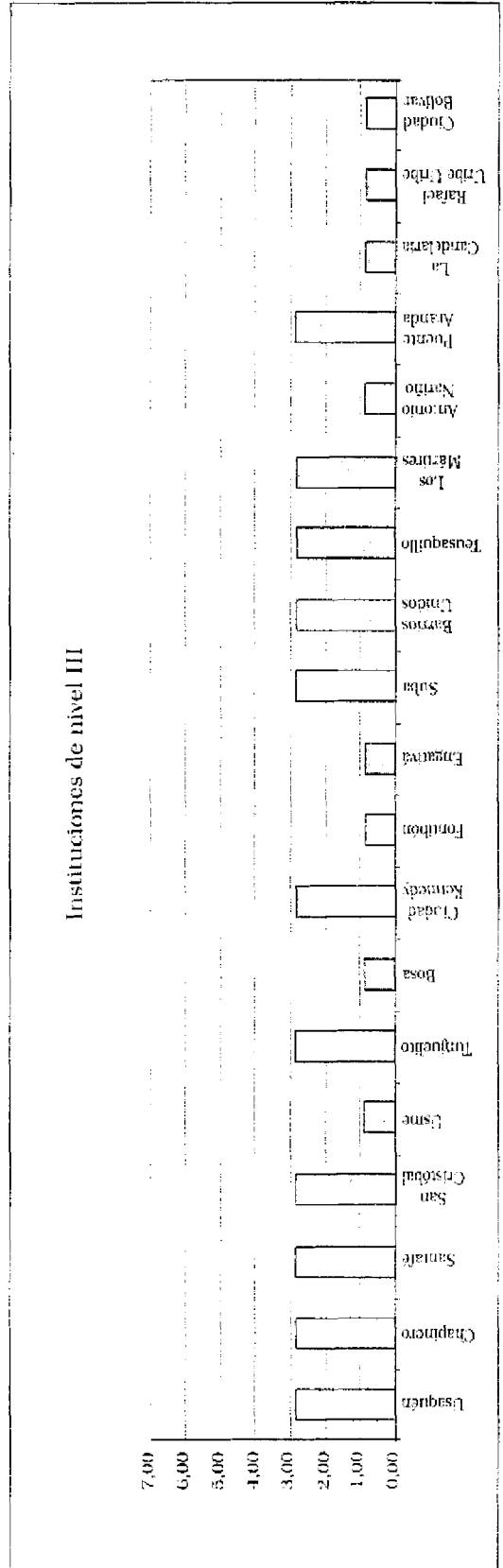
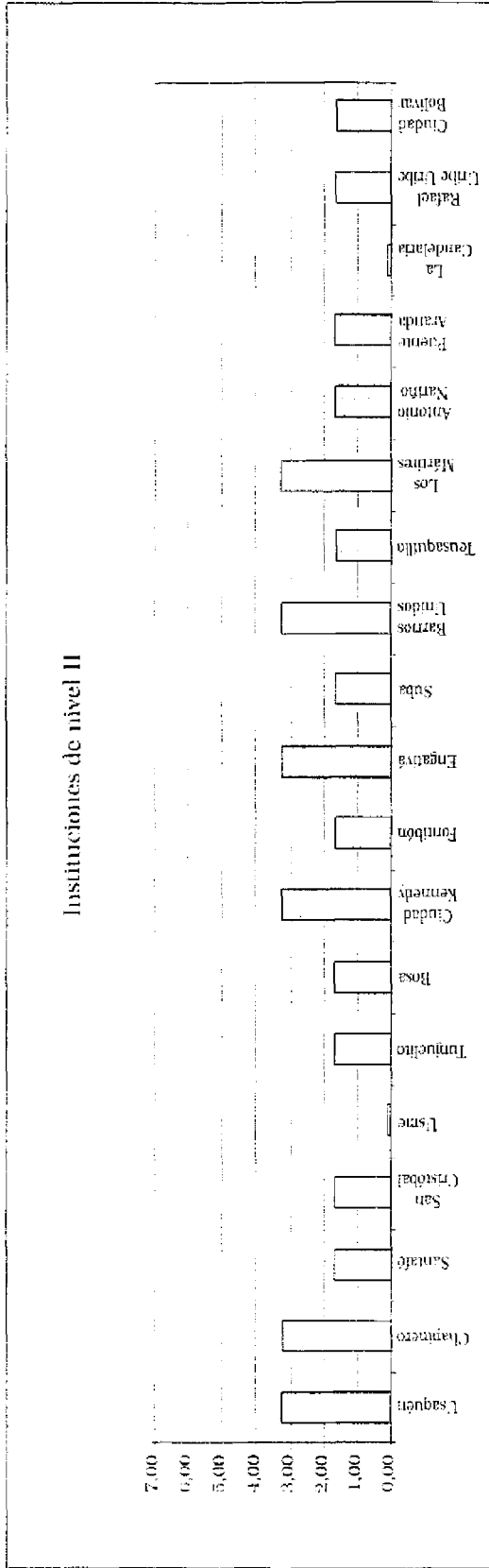

Gráfico 18D

INDICADORES DE CAPACIDAD DE EXPANSIÓN DE LOS SERVICIOS DE URGENCIAS Y ALBERGUE SEGÚN INFRAESTRUCTURA SANITARIA SATISFACTORIA POR LOCALIDAD

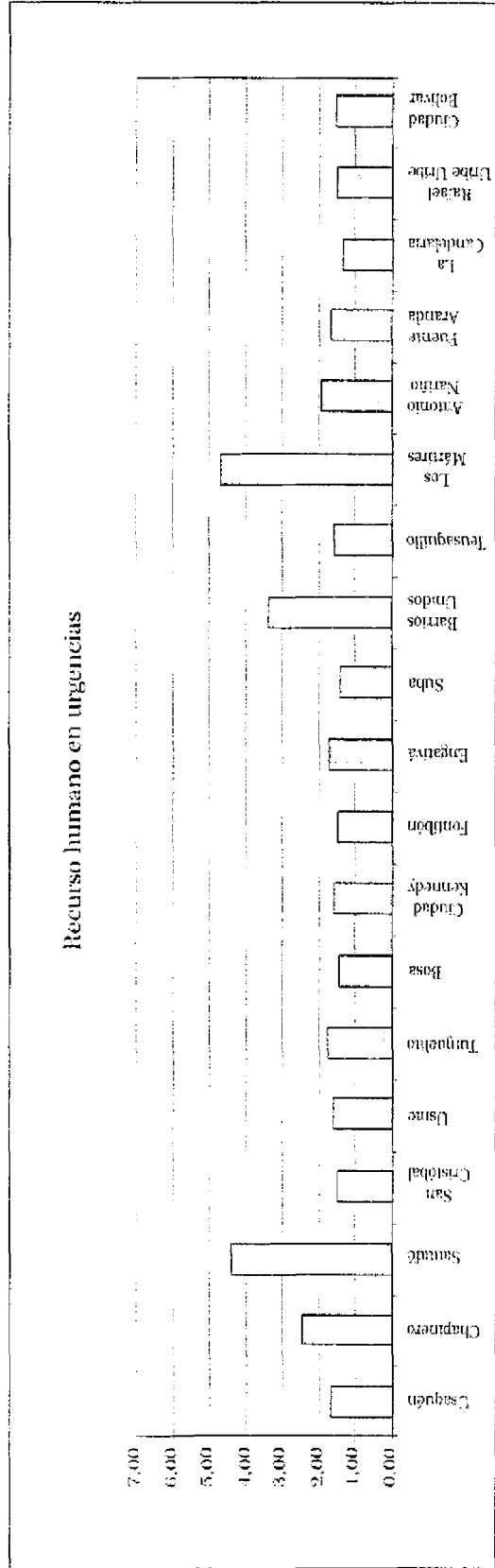
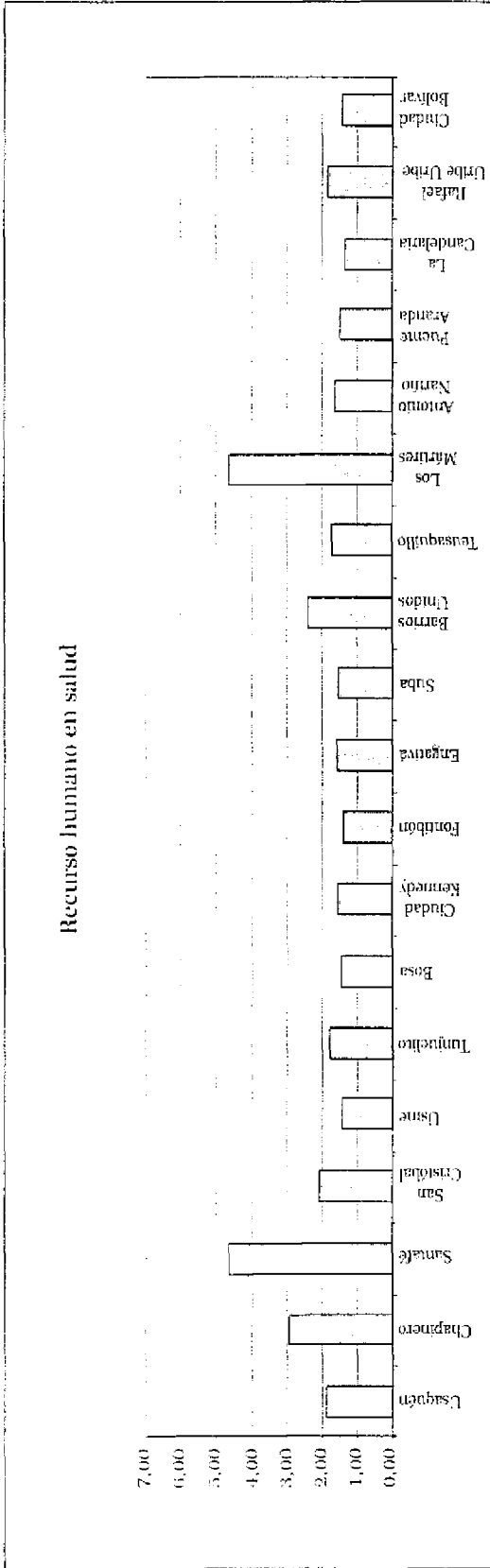

Gráfico 18E

INDICADORES DE ESPACIOS PÚBLICOS DE ATENCIÓN MASIVA Y NÚMERO DE SOCORRISTAS POR LOCALIDAD

Espacios públicos para atención masiva

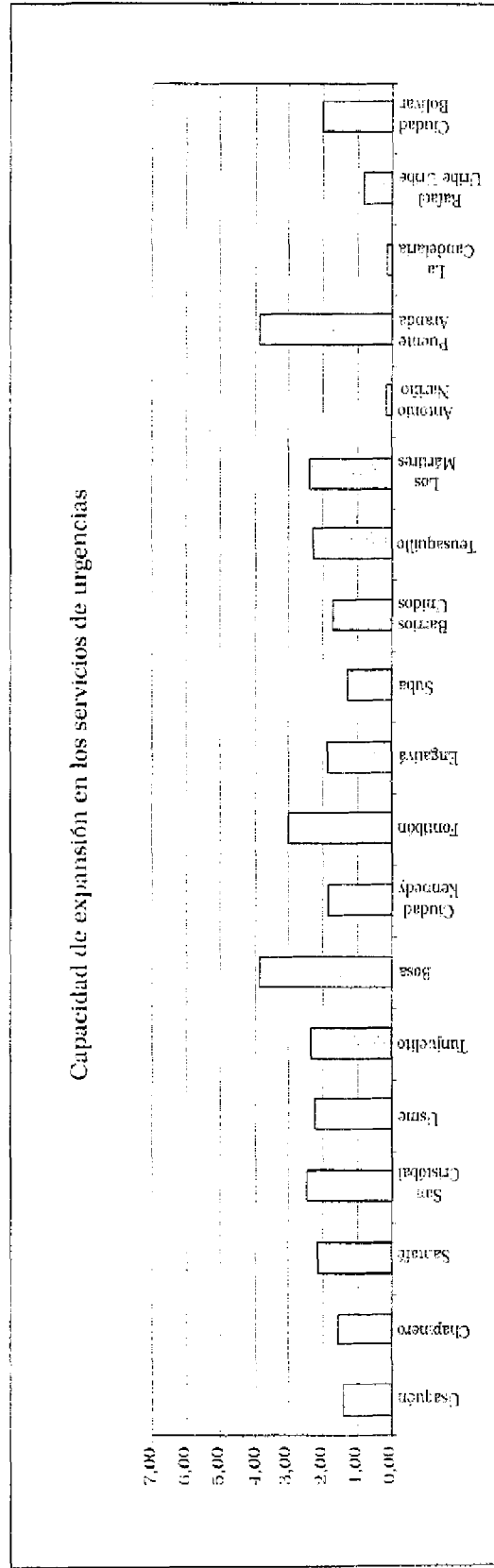
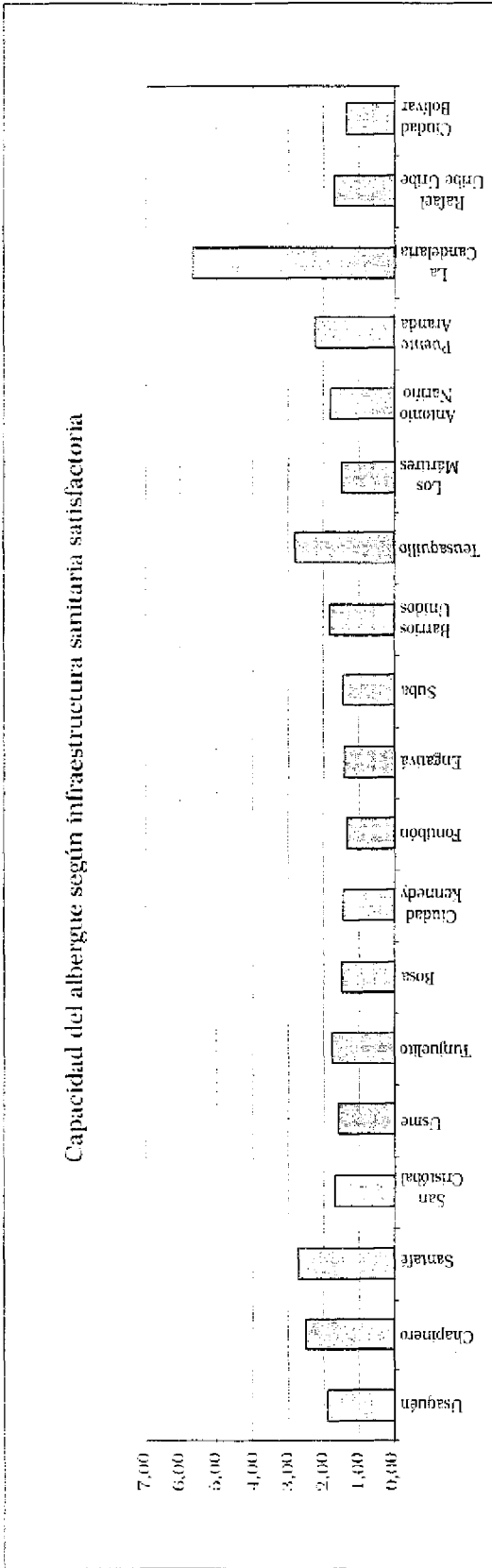
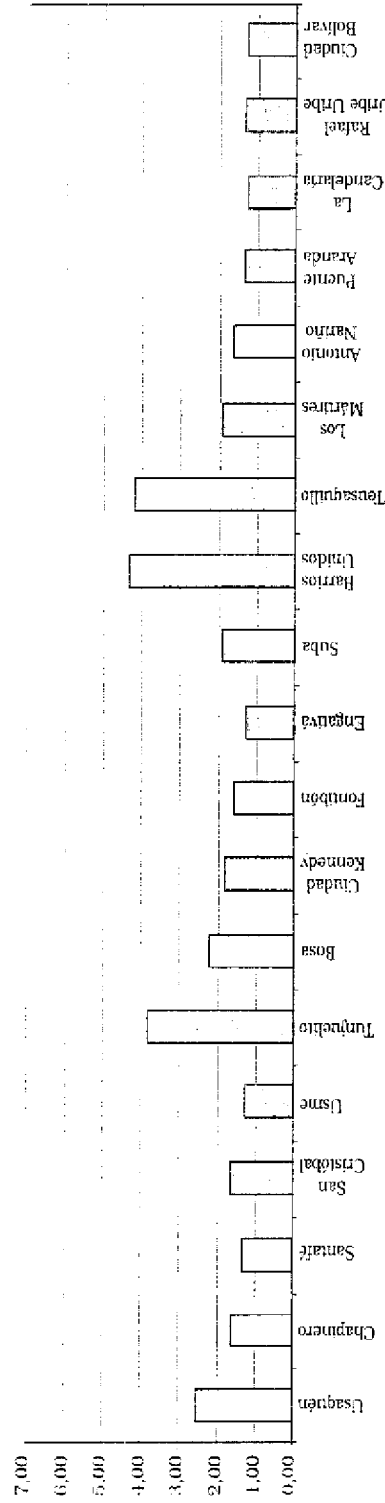

Número de socorristas



Gráfico 18F

INDICADORES DE NÚMERO DE BOMBEROS Y CENTROS DE POLICIA POR LOCALIDAD

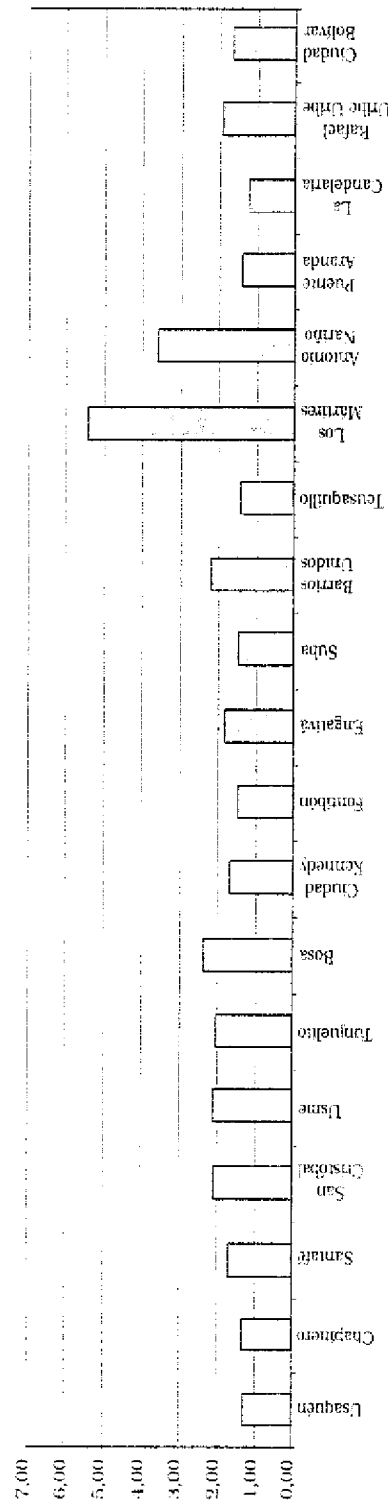

Gráfico 18C

INDICADORES DE MÁQUINAS DE BOMBEROS Y NÚMERO DE AMBULANCIAS POR LOCALIDAD



Gráfico 18H
 INDICADORES DE NIVEL DE DESARROLLO Y OPERATIVIDAD DEL COMITÉ DE EMERGENCIAS POR LOCALIDAD

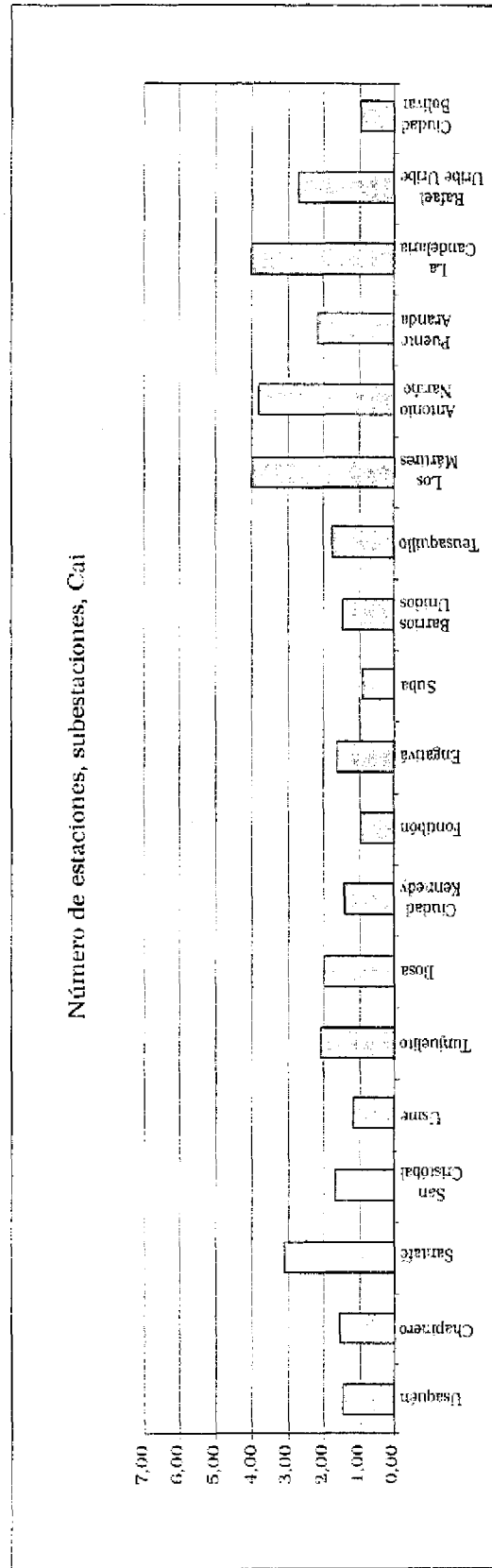
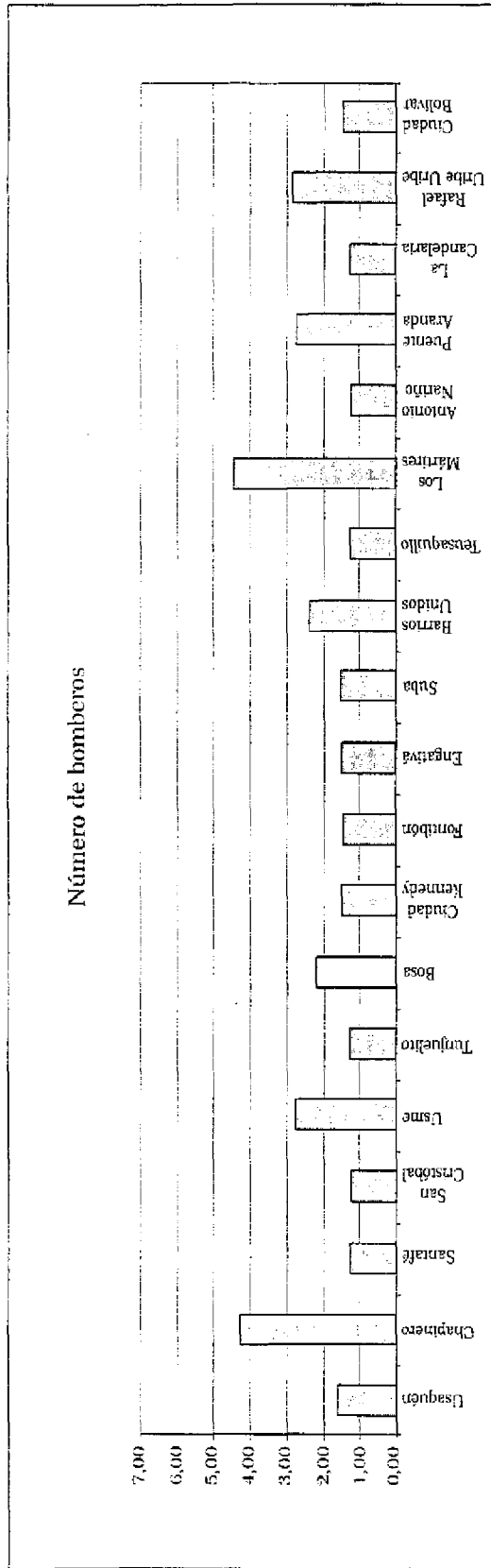

Gráfico 19
RESILIENCIA POR LOCALIDAD

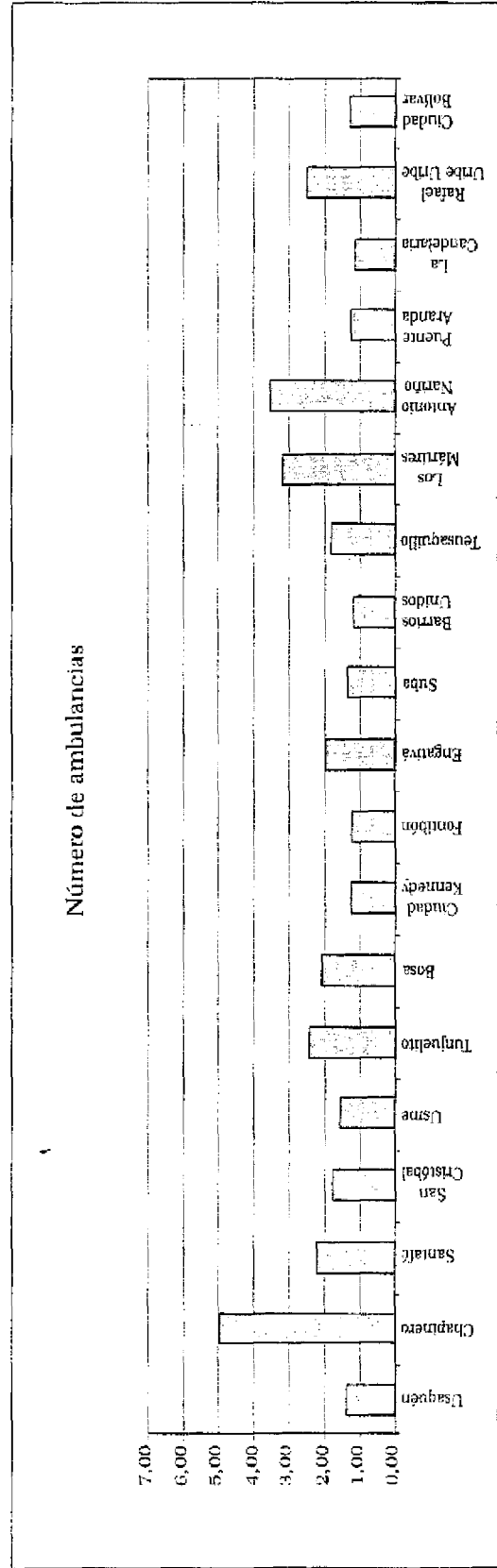
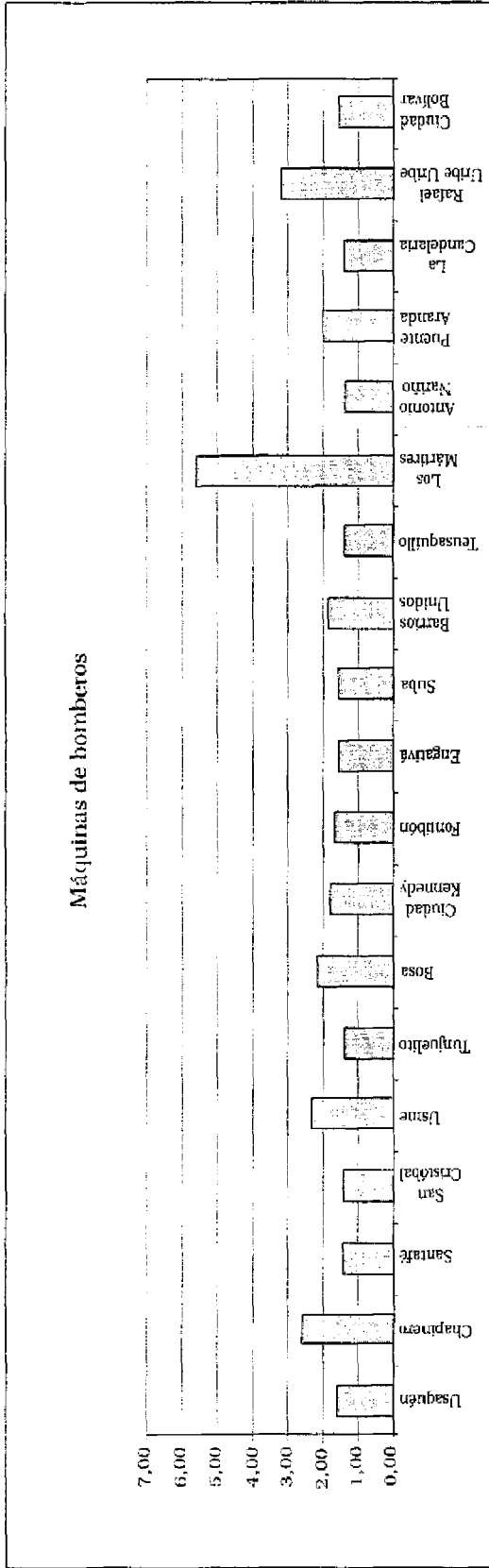

Gráfico 20A

INDICADORES DE AMENAZA POR LOCALIDAD

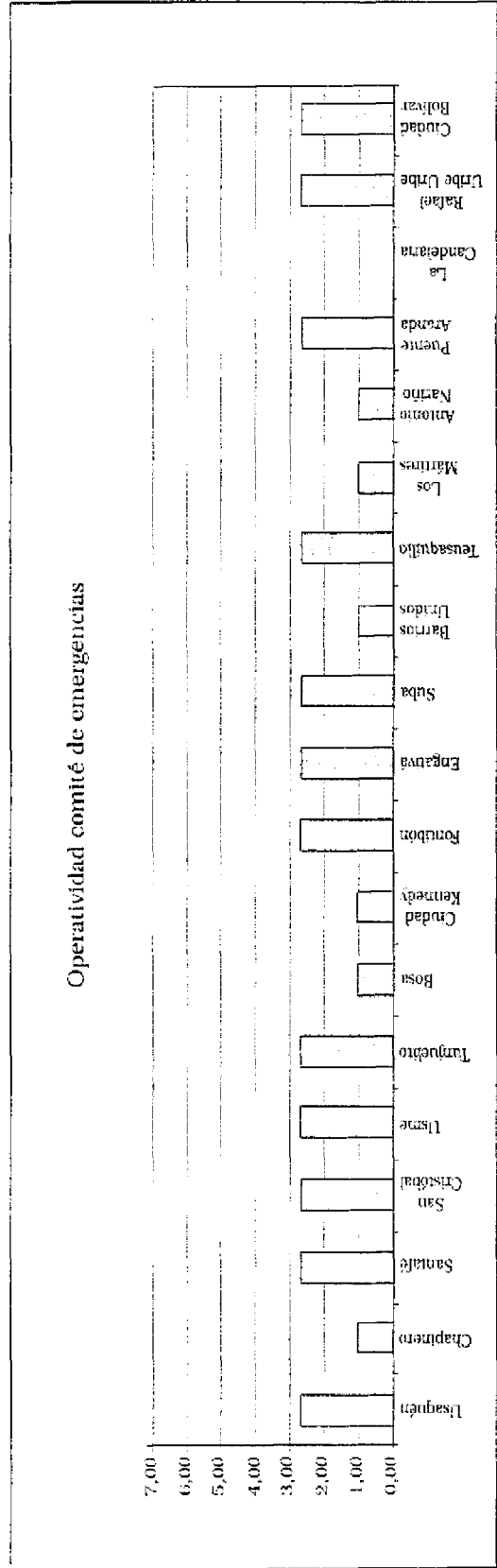
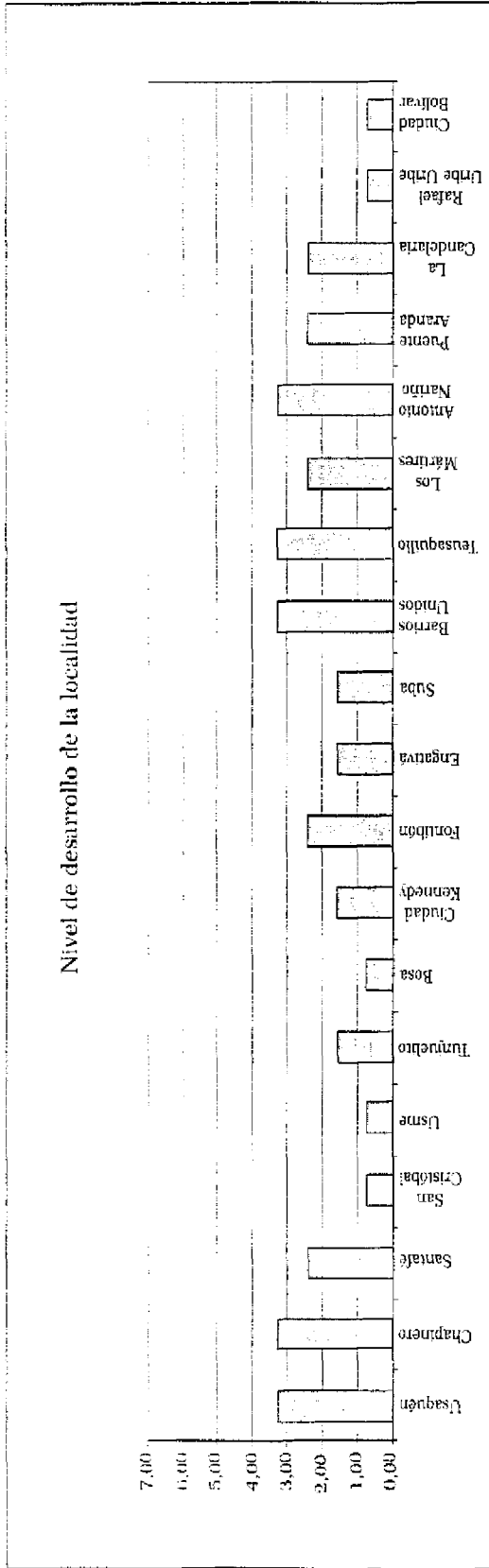

Gráfico 20B

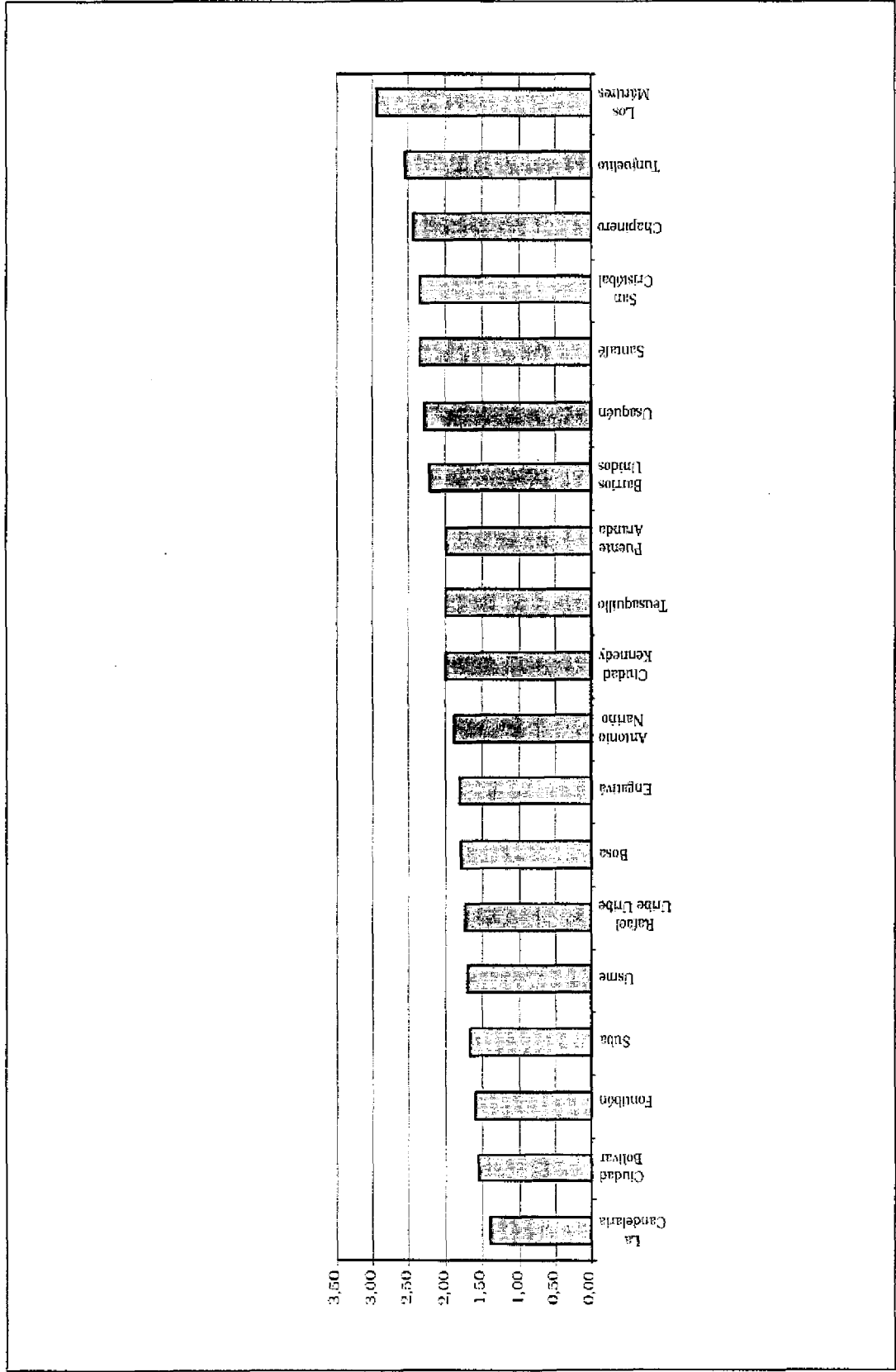
INDICADORES DE AMENAZA POR LOCALIDAD

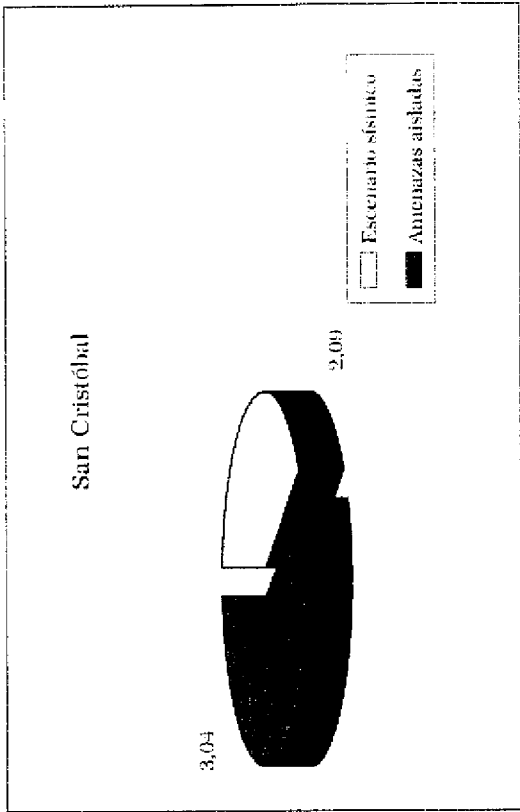
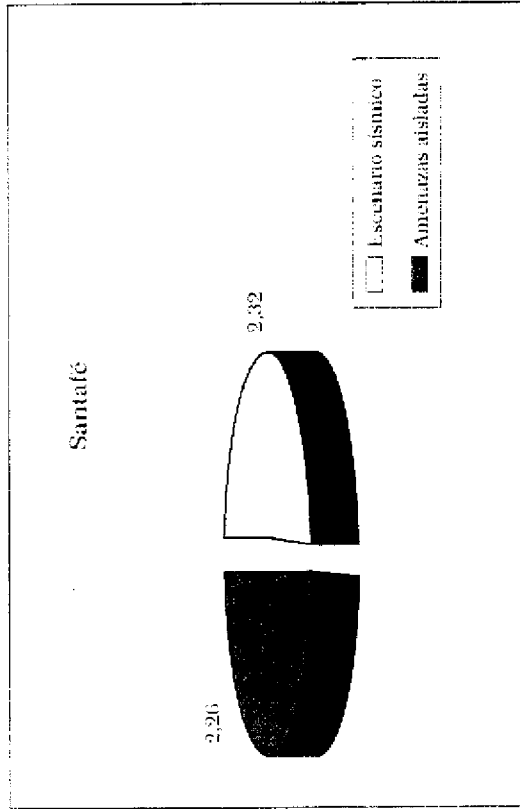
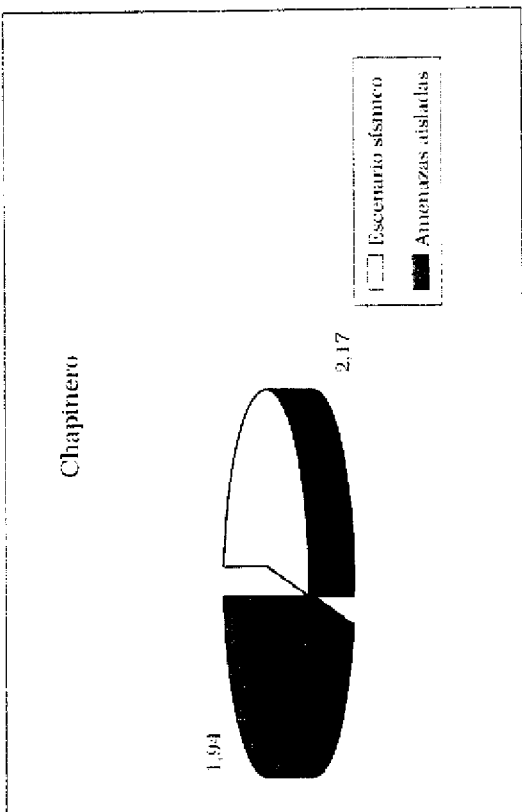
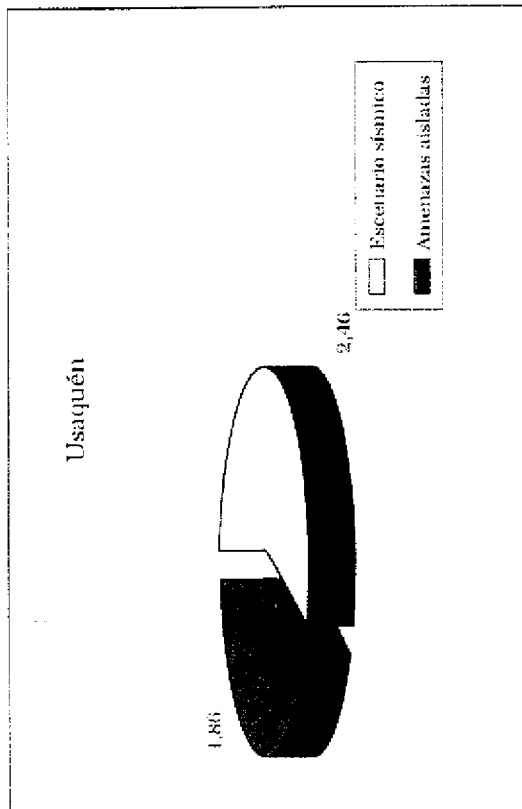

Gráfico 20C

INDICADORES DE AMENAZA POR LOCALIDAD

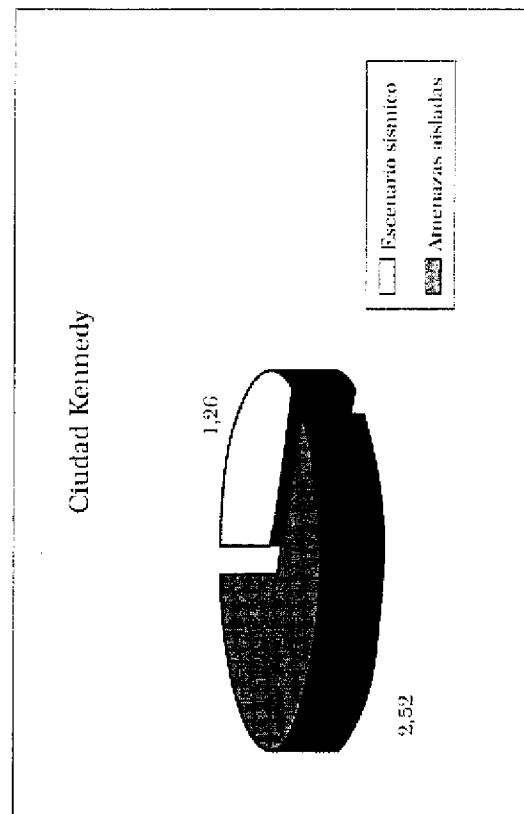
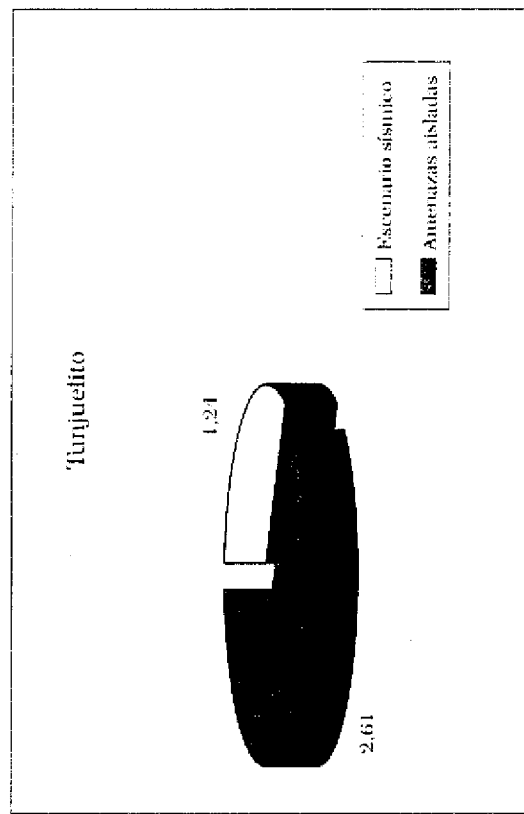
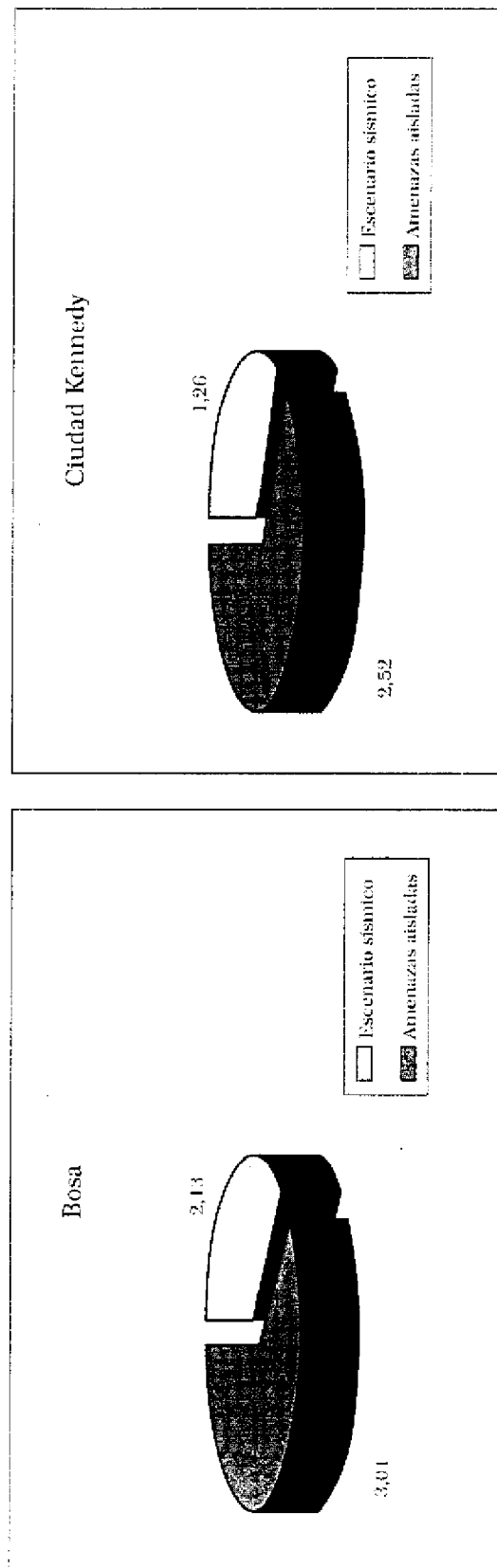
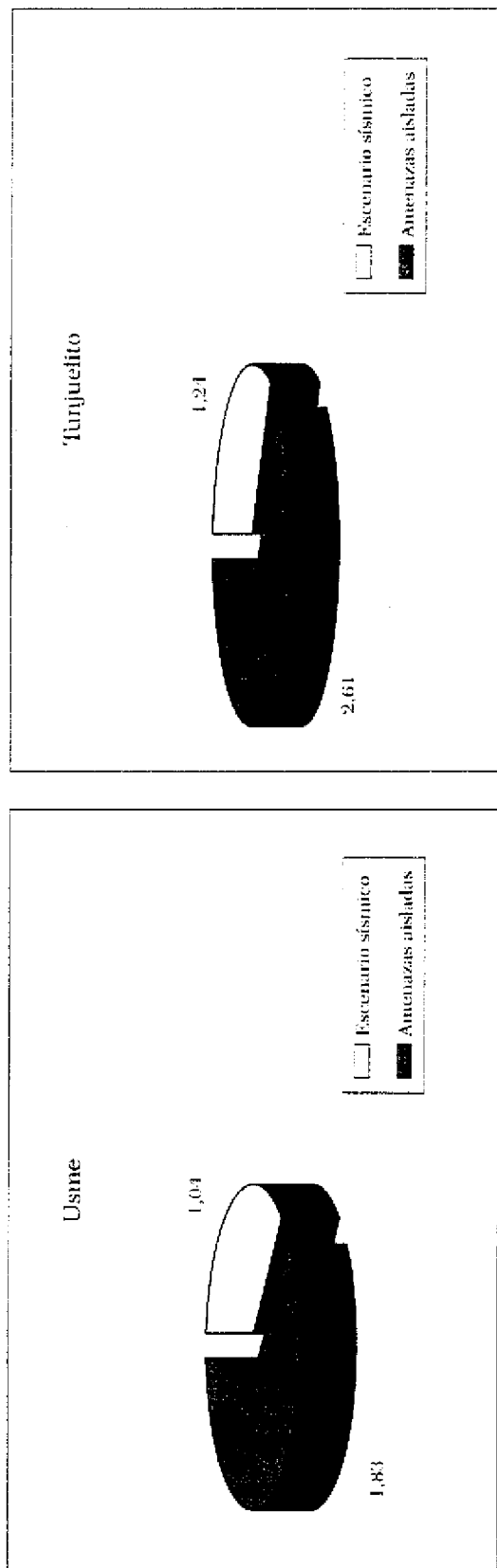

Gráfico 20D

INDICADORES DE AMENAZA POR LOCALIDAD

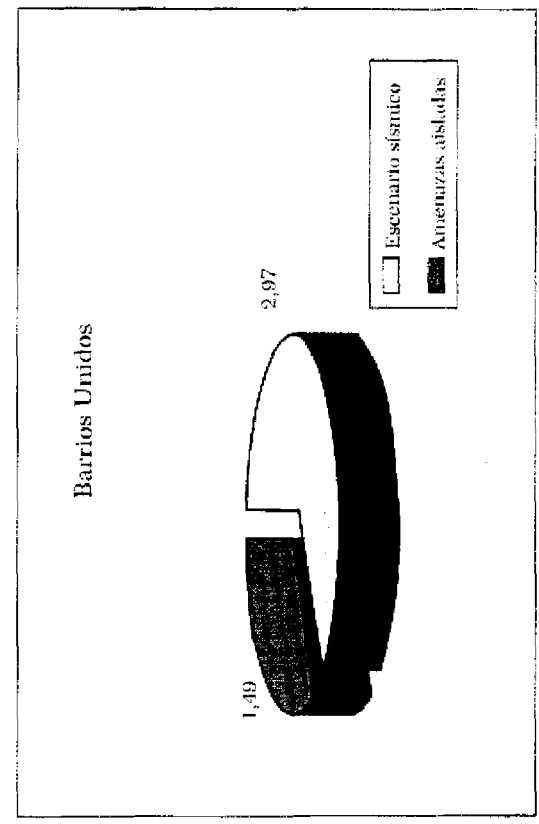
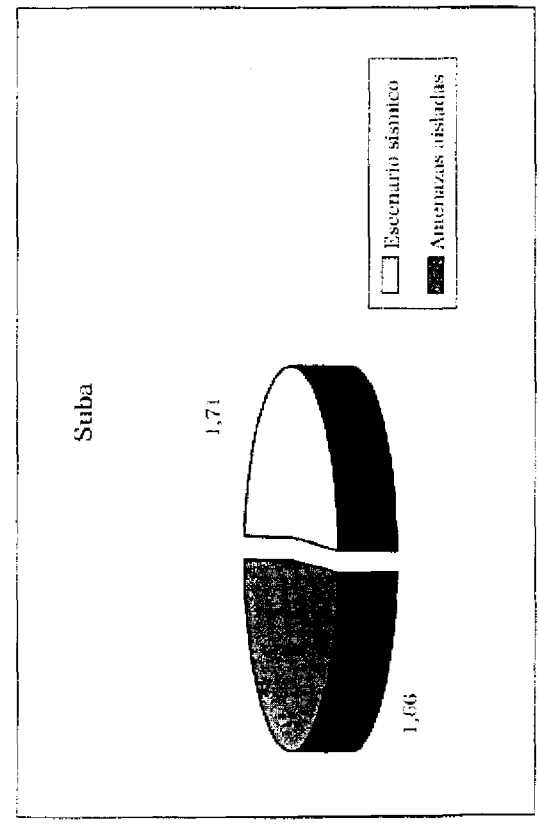
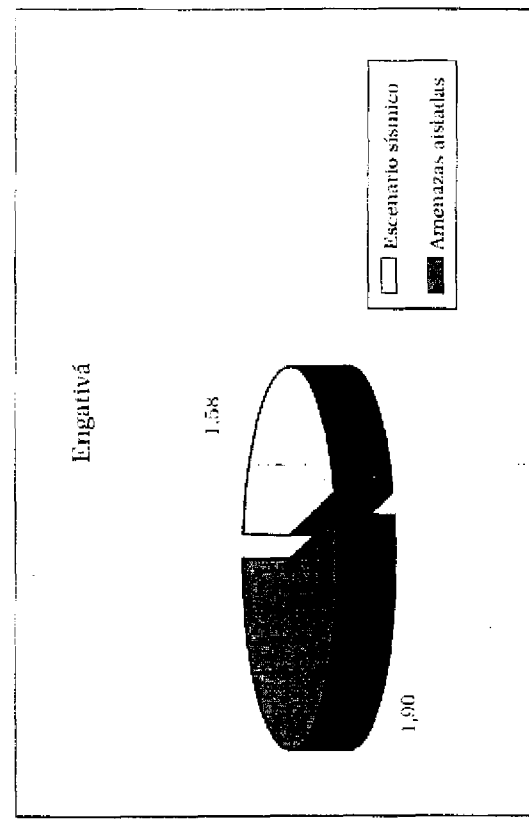
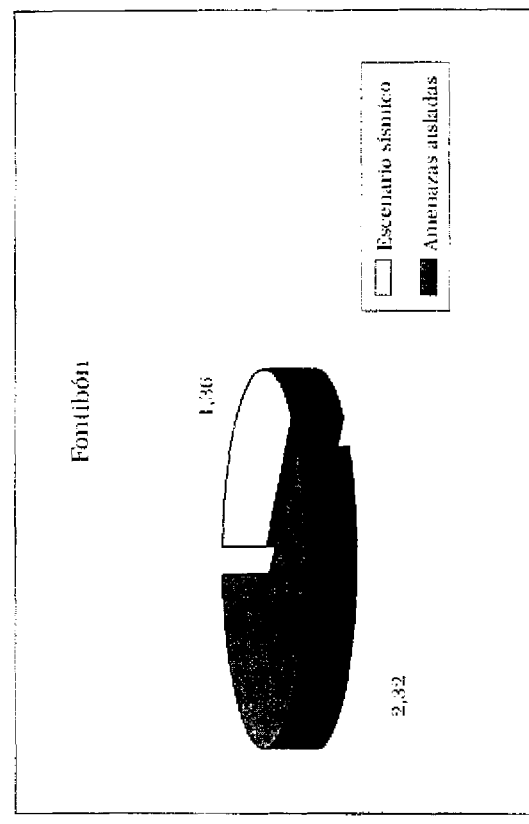